

**CONTROL
TECHNIQUES**TM

COMMANDER C

GENERAL PURPOSE
LOW VOLTAGE AC DRIVES



Simple, reliable
motor control

0.25 kW to 132 kW
(0.33 HP to 200 HP)

Nidec
All for dreams

Commander C the 6th generation

Commander Drives have established the standard of excellence in motor control since 1983.

The new Commander C series is built on six generations of knowledge to meet advanced requirements in a wide range of applications and provide optimum user experience.



Key Highlights

Simple, reliable motor control

Straightforward installation and commissioning

For a quick motor set-up the key parameters are printed on the front of the drive so you can be up and running within seconds.

Set just 4 parameters to get your drive started

Simply select the motor rated current, RPM, voltage and power factor from parameters 6 to 9.

Equipped with the latest energy saving features

Commander C helps you maximize productivity while keeping operating costs down.

Up to 180% over-load for high torque applications.

Dual Safe Torque Off (STO)

Commander C300 (only) features a Dual Safe Torque Off input, certified to SIL3/PLe safety rating and compliant with EN/IEC 61800-5-2.

Plug-in options for advanced control

Communication interfaces are available as options to support a wide range of controllers.

On board PLC

Embedded intelligence eliminates the need for an external controller, saving both on cost and space when installing Commander C drives into a system.

Wide availability and outstanding service

Through our local Drive Centres.

Whatever your
application,
Commander C
is the perfect
solution across
industry.



Pumping, Ventilating & Compressing

- Improved energy efficiency during periods of low demand
- On board PLC & PID functionalities make advanced control easy and efficient without the need of an external controller
- Skip Frequencies allow users to easily avoid equipment resonant frequencies, reducing high vibration levels
- Supply Loss Ride Through will keep the drive up and running through most power outages

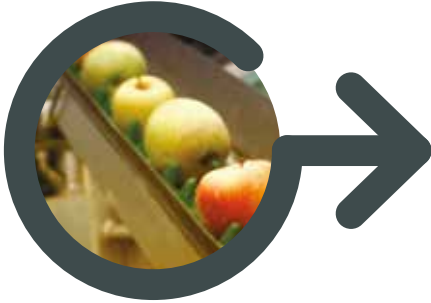

Conveying

- Accurate remote speed control with fieldbus communications
- S-ramp acceleration / deceleration profiling provides smooth speed transitions minimizing machine jerk
- Overload capacity up to 180% to add stability
- Avoids early wear and tear of the equipment



Lifting, Hoisting & Winching

- Adjustable mechanical brake sequencing with torque proving function - no need for an external controller
- Embedded PLC functionality can manage local I/O reducing the need for an external controller



Access Control

- Smooth motion with enhanced open loop control
- Small physical size allows the drive to be mounted easily in smaller control cabinets
- Highly reliable in harsh environments, providing long lasting service

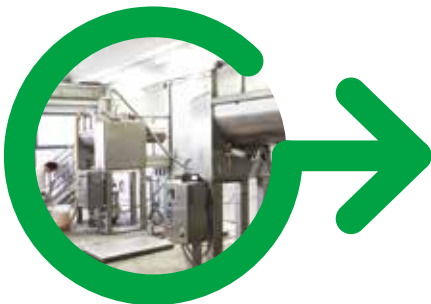

Processing (Mixers, Crushers, Agitators, Centrifuges, Extruders)

- Ease of integration to external PLC or other management systems through powerful networking options
- Conformal coating for enhanced environmental protection
- Overload capacity up to 180%
- Highly stable motor control

Commander C features & accessories

Easy motor pairing and performance control

- Fixed boost by default for easy set-up
 - Multi-motor control
- V/Hz for advanced performance
 - 100% torque available to 1 Hz
 - Slip compensation
 - Square law V/F mode
 - Dynamic V/F mode
 - Auto tune (stationary and rotating)
- Open loop vector
- Enhanced open loop RFC
 - Closed current loop for greater stability
 - Auto tuning (stationary and rotating)



Communication options

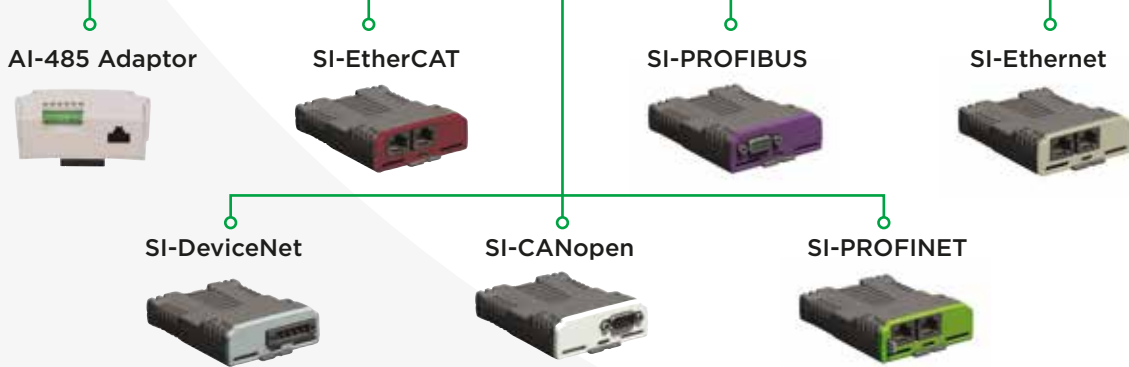

Flexible connectivity

The 'SI' Interface in Commander C enables integration with a wide range of available industry standard fieldbuses or extended I/O to allow remote control and diagnostics across different networks. Additionally, the AI-485 Adaptor option permits connection to RS485 networks using Modbus RTU.

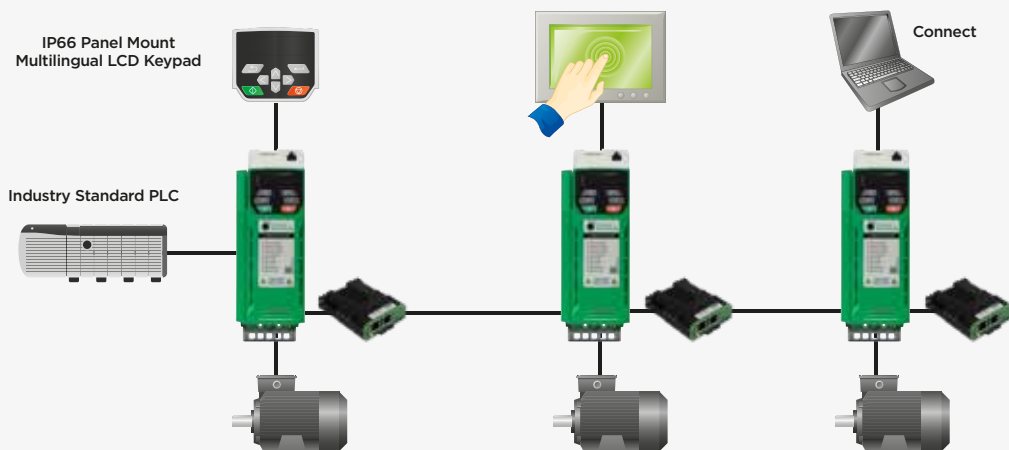

Simple set-up, installation and configuration

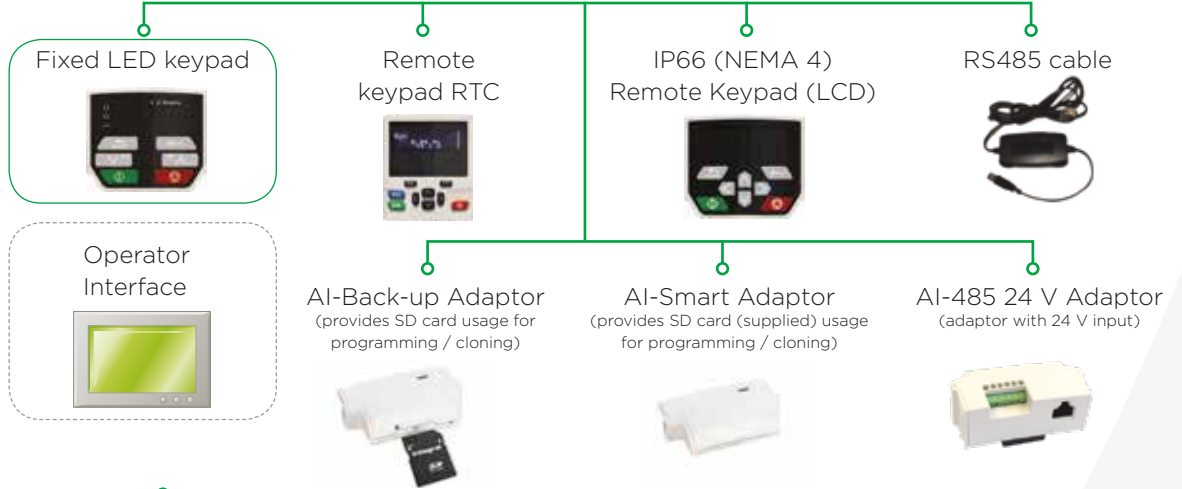

Robust and reliable design

- PCBs conformal coated for resilience to harsh environments
- Patented air flow system cools and protects components
- Voltage tolerance for smooth operation during variable supply
- Intelligent 3 speed replaceable fan with failure detection
- Trip avoidance features take action instead of tripping out:
 - Load shedding reduces speed at current limits
 - Supply loss ride-through runs during brown outs
- High overload capability - 180% for 3 s (RFC-A mode) or 150% for 60 s (Open loop mode)
- Ingress protection: IP21-UL open class (NEMA 1)

More control, less cost

- On board PLC
- Built-in independent PID control

Input/Output

SI-I/O



- 4 x Digital I/O
- 3 x Analog inputs (default) / Digital inputs
- 1 x Digital input
- 2 x Relays

Onboard



- 3 x Analog I/O
- 5 x Digital I/O
- 1 x Relay
- 2 X STO (C300 only)

Energy saving

- **Dynamic V/Hz** - improves efficiency by reducing motor voltage during low demand
- **98% efficient** - only 2% of energy is lost during the conversion process
- **Low power standby mode** - drives can be idle for significant periods, saving energy
- **Automatic 3-speed cooling fan** - keeps energy usage & acoustics to a minimum by intelligently responding to load and the environment
- **Square Law V/F mode** - optimized for quadratic loads like pumps & fans to reduce motor losses



Intuitive commissioning software

For fast task based commissioning and easy maintenance **Connect** offers a familiar Windows™ interface and intuitive graphical tools to enhance data analysis. The dynamic drive logic diagrams allow the visualisation and control of the drive in real time. The parameter browser enables viewing, editing and saving of parameters as well as importing parameter files from our legacy drives.

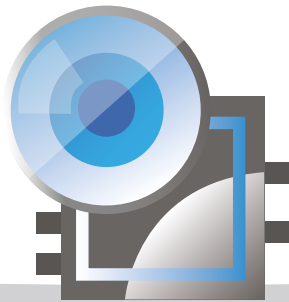

Advanced machine control

For more advanced applications **Machine Control Studio** provides a flexible and intuitive environment for programming. This is possible thanks to the on board PLC that increases the drives functionality at no extra cost.

Control Techniques also provides support for customers' own function block libraries, with on-line monitoring of program variables with user defined watch windows and help for on-line change of program, in line with current PLC practice.

Online support



The Diagnostic Tool App is a fast and simple tool, which allows users to quickly solve any error codes that the drive may show. Built within the app are easy to locate wiring diagrams for first time setup and fault finding with links to the relevant comprehensive manuals.

The app also has full contact details of the technical support teams around the world to aid you with technical assistance.

Available for Apple, Android and Windows™, download the app for free at

www.controltechniques.com/mobile-applications

Drive-Setup.com

Free access web pages provide 'how-to' videos, step by step guides and comprehensive technical manuals.

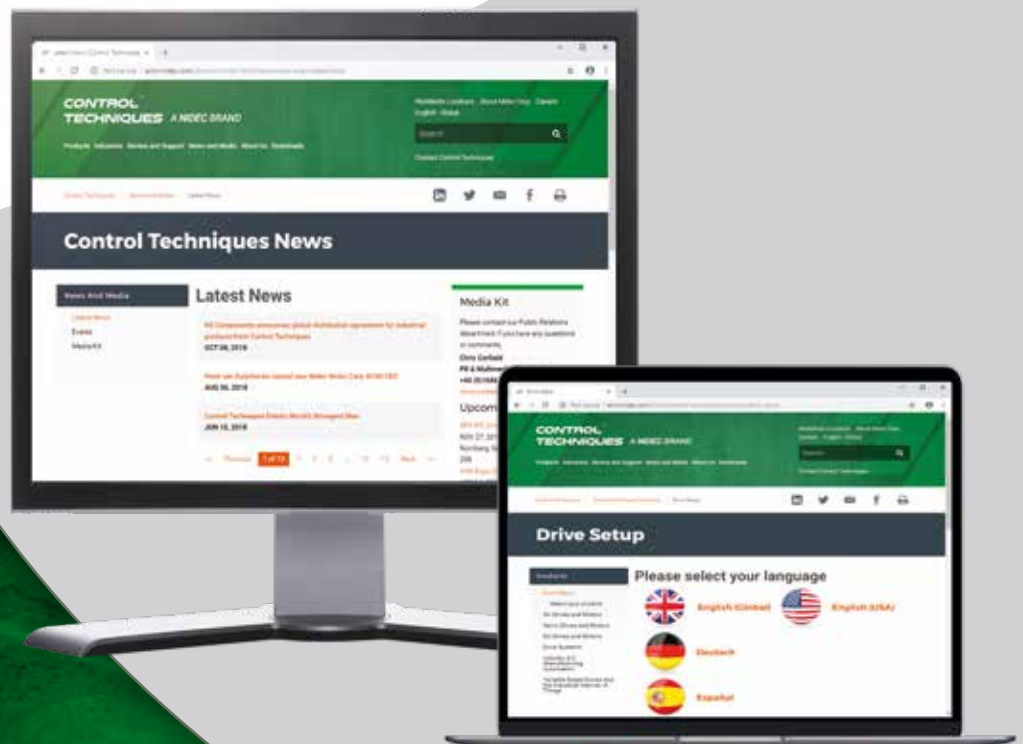

Commander C specifications

Environment	
Ambient Operating Temperature	Size 1 - 4: -20°C to 40°C (-4°F to 104°F) @ 3 kHz switching freq. Operation to 60°C (140°F) with de-rating Size 5 - 9: -20°C to 40°C (-4°F to 104°F) @ 3 kHz switching freq. Operation to 55°C (131°F) with de-rating
Cooling method	Forced convection
Humidity	95 % non-condensing at 40 °C (104 °F)
Storage Temperature	Size 1 - 4: -40°C to 60°C (-40°F to 140°F) – 24 months Max. Size 5 - 9: -40°C to 55°C (-40°F to 131°F) – 24 months Max.
Altitude	De-rate the continuous output current by 1% for every 100 m (328 ft) above 1000 m (3,280 ft) to a maximum of 3000 m (9,840 ft)
Vibration	Tested in accordance with IEC 60068-2-64 and IEC 60068-2-6
Mechanical Shock	Tested in accordance with IEC 60068-2-27 and IEC 60068-2-29
Enclosure Rating	IP20, NEMA 1 conduit kits available
Electromagnetic Capability	IEC/ EN 61800-3 Immunity and Emissions EN 61000-6-2: Immunity for industrial environments EN 61000-6-4: Emissions for industrial environments EN 61000-3-2: Harmonic current emissions An EMC data sheet is available on request
RoHS	Complies with the Restriction of Hazardous Substances Directive (2011/65/EU)
AC Supply Requirements	
Voltage	100 V models: 100 to 120 Vac ±10% 200 V models: 200 to 240 Vac ±10% 400 V models: 380 to 480 Vac ±10%
Phase	1Ø and 3Ø (Model dependent)
Maximum Supply Imbalance	2% negative phase sequence, 3% voltage imbalance between phases
Input Frequency	45 to 66 Hz
Input Displacement Power Factor	0.97
Control	
Switching Frequency	Size 1 - 4: 0.667, 1, 2, 3, 4, 6, 8 12 & 16 kHz Size 5 - 9: 2, 3, 4, 6, 8 12 & 16 kHz
Output Frequency Range	0 to 550 Hz
Frequency Accuracy	±0.02% of full scale
Frequency Resolution	0.01 Hz
Analog Input Resolution	Voltage mode: 11 bits (unipolar) Current mode: 11 bits
Braking	Dynamic braking transistor included, requires external resistor
Protection	
DC Bus Undervoltage Trip	100 V models: 175 Vdc 200 V models: 175 Vdc 400 V models: 330 Vdc
DC Bus Overvoltage Trip	Frame sizes 1 - 4: 100 V models: 510 Vdc 200 V models: 510 Vdc 400V models: 870 Vdc Frame size 5 - 9: 200V models: 415 Vdc 400 V models: 830 Vdc
Drive Overload Trip	Programmable: Default settings: 180% for 3s, 150% for 60s
Instantaneous Overcurrent Trip	220% of rated motor current
Phase Loss Trip	DC bus ripple threshold exceeded
Over-temperature Trip	Drive heatsink temperature exceeds 95°C (203°F)
Short Circuit Trip	Protects against output phase-to-phase fault
Ground Fault Trip	Protects against output phase-to-ground fault
Motor Thermal Trip	Electronically protects the motor from overheating due to loading conditions
Approval & Listings	
UL, cUL	UL file NMMS/8: E171230
CE	CE approval
EU	These products comply with the Restriction of Hazardous Substances Directive (2011/65/EU), the Low Voltage Directive (2014/35/EU) and the Electromagnetic Compatibility Directive, (2014/30/EU).
RCM	RCM Registered supplier No. 12003815281
ISO	Manufacturing facilities comply with ISO 9001:2015 and ISO 14001
TÜV	C300 models only: The Safe Torque Off (STO) function may be used as a safety component of a machine. Type examination certificates by TÜV Rheinland: Frame sizes 1 - 4: No. 01/205/5383,03/18 Frame sizes 5 - 9: No. 01/205/5387,02/18 Functional safety parameters: EN ISO 13849-1 - Cat 4, PLe EN61800-5-2/EN62061/IEC 61508 - SIL 3 UL functional safety approval: FSPC E171230



Terminal diagram

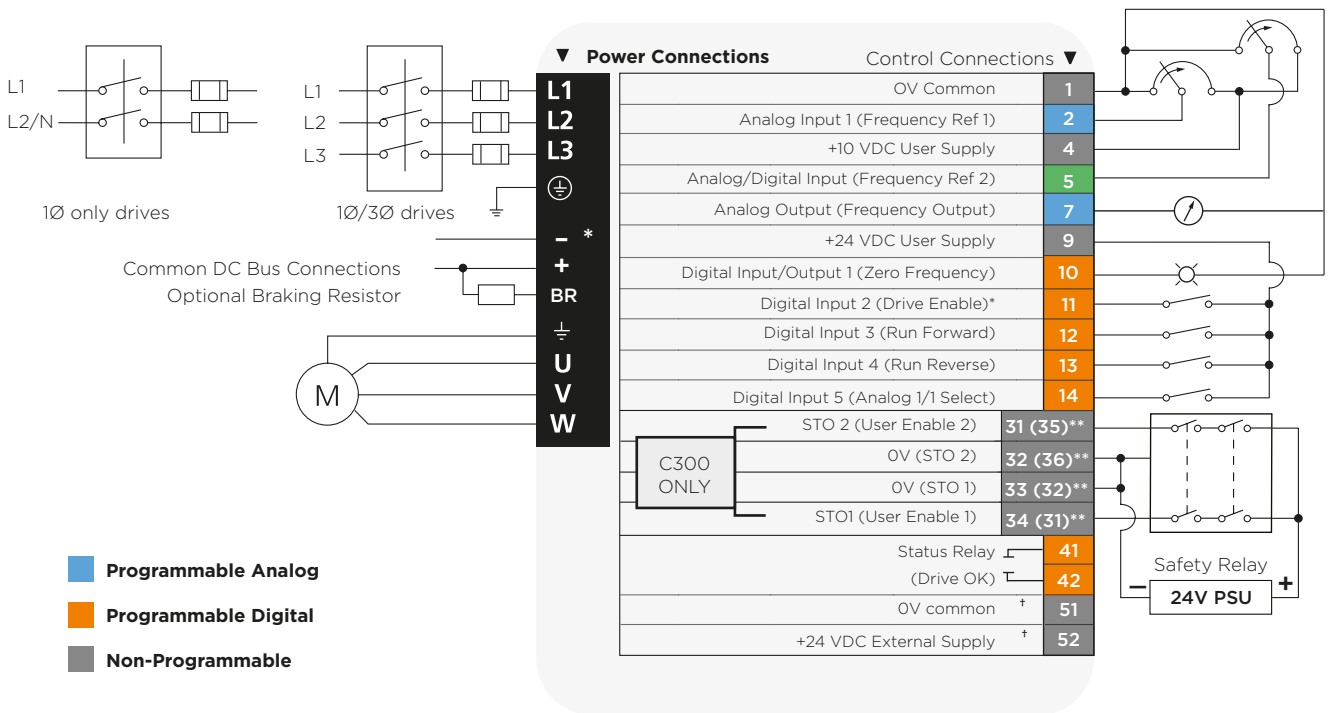

- Programmable Analog
- Programmable Digital
- Non-Programmable

Pin#	Default Function	Type/Description	Notes
1	OV Common	Common for external analog signals	
2	Frequency reference 1	Single ended analog input 11 bit	0 to +10 Vdc, 0-20 mA or 4-20 mA or 20-4 mA or 20-0 mA
4	+10 Vdc user supply	Reference supply	5 mA Output current
5	Frequency reference 2	Single ended analog input 11 bit or digital input	0 to +10 Vdc or 0 to +24 Vdc
7	Output frequency	Single ended analog output	0 to +10 Vdc
9	+24 Vdc user supply	Digital I/O supply	100 mA
10	At zero frequency	Digital I/O 1	0 to +24 Vdc
11	Enable*	Digital input 2	0 to +24 Vdc
12	Run forward	Digital input 3	0 to +24 Vdc
13	Run reverse	Digital input 4	0 to +24 Vdc
14	Analog input 1/2 select	Digital input 5	0 to +24 Vdc
31 (35)**	Safe Torque Off/Drive enable	STO 2	0 to +24 Vdc
32 (36)**	OV STO 2	OV STO 2	OV common for STO 2
33 (32)**	OV STO 1	OV STO 1	OV common for STO 1
34 (31)**	Safe Torque Off/Drive enable	STO 1	0 to +24 Vdc
41	Status relay (drive OK)	Normally open contact	2 A, 240 Vac, 0.5 A, 30 Vdc inductive load
42			
51 †	OV common	Common for backup supply	
52 †	+24 Vdc external supply	Backup control supply	24 Vdc, 40 W

C300 ONLY

Notes:

* C300 uses STO, so terminal 11 is unassigned

** Frames 1 to 4 (Frames 5 to 9) - different terminals by frame size

Frames 1 to 4 - the OV terminals on the Safe Torque Off are isolated from each other and the OV common

Frames 5 to 9 - the OV terminals on the Safe Torque Off are not isolated from each other and the OV common

The Safe Torque Off / Drive enable terminal is a positive logic only input

† Terminal 51 and 52 must be connected to an external 24 V power supply if backup is required (frame sizes 6-9 only)

Drive: Ordering guide

How to select a drive

Electrical Considerations

- What is the supply voltage?
- Single or 3Ø input power?
- What is the motor rating?
- Continuous current - FLA (Full Load Amps)
- Select the drive based on motor Amps rather than horsepower

Drive Mechanical Mounting

- Panel mounting - as standard
- Wall mounting - UL conduit kits are available
- Through panel mounting - frames 5 and up



Key:

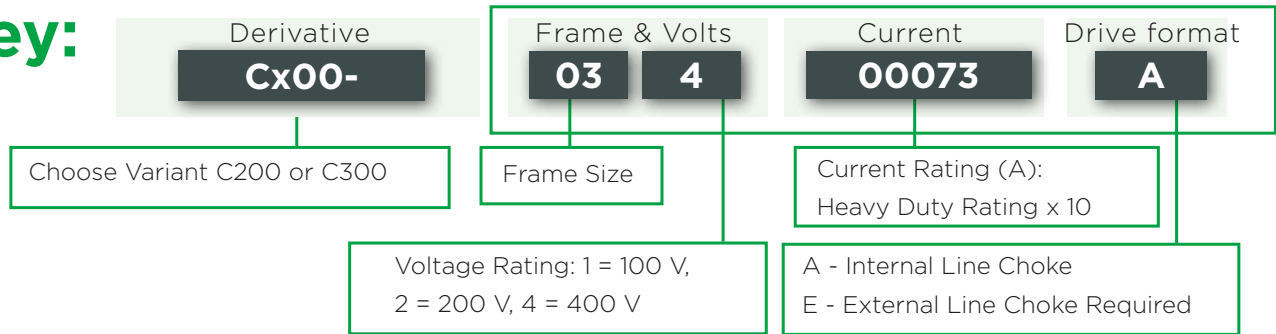

Dimensions:



Frame size	Dimensions H x W x D mm (in)	Weight kg (lb)
1	160 x 75 x 130 (6.3 x 2.95 x 5.1)	0.75 (1.65)
2	205 x 75 x 150 (8.07 x 2.95 x 5.9)	1.3 (3.0)
3	226 x 90 x 160 (8.9 x 3.54 x 6.3)	1.5 (3.3)
4	277 x 115 x 175 (10.9 x 4.5 x 6.9)	3.13 (6.9)
5	391 x 143 x 200 (15.39 x 5.63 x 7.87)	7.4 (16.3)
6	391 x 210 x 227 (15.39 x 8.27 x 8.94)	14 (30.9)
7	557 x 270 x 280 (21.93 x 10.63 x 11.02)	28 (61.70)
8	804 x 310 x 290 (31.65 x 12.21 x 11.42)	52 (114.6)
9E	1069 x 310 x 290 (42.09 x 12.21 x 11.42)	46 (101.4)
9A	1108 x 310 x 290 (43.62 x 12.21 x 11.42)	66.5 (146.6)

100/120 Vac ±10%							
Order Code	Supply Phases	Heavy Duty			Normal Duty		
		Max Cont.Current (A)	Motor Power (kW)	Motor Power (HP)	Max Cont.Current (A)	Motor Power (kW)	Motor Power (HP)
Cx00-011 00017A	1	1.7	0.25	0.33	For Normal Duty applications, use Heavy Duty ratings.		
Cx00-011 00024A	1	2.4	0.37	0.5			
Cx00-021 00042A	1	4.2	0.75	1			
Cx00-021 00056A	1	5.6	1.1	1.5			

200/240 Vac ±10%

Order Code	Supply Phases	Heavy Duty			Normal Duty		
		Max Cont.Current (A)	Motor Power (kW)	Motor Power (HP)	Max Cont.Current (A)	Motor Power (kW)	Motor Power (HP)
Cx00-012 00017A	1	1.7	0.25	0.33	For Normal Duty applications, use Heavy Duty ratings.		
Cx00-012 00024A	1	2.4	0.37	0.5			
Cx00-012 00033A	1	3.3	0.55	0.75			
Cx00-012 00042A	1	4.2	0.75	1			
Cx00-022 00024A	1/3	2.4	0.37	0.5			
Cx00-022 00033A	1/3	3.3	0.55	0.75			
Cx00-022 00042A	1/3	4.2	0.75	1			
Cx00-022 00056A	1/3	5.6	1.1	1.5			
Cx00-022 00075A	1/3	7.5	1.5	2			
Cx00-032 00100A	1/3	10	2.2	3			
Cx00-042 00133A	1/3	13.3	3	3			
Cx00-042 00176A	3	17.6	4	5			
Cx00-052 00250A	3	25	5.5	7.5	30	7.5	10
Cx00-062 00330A	3	33	7.5	10	50	11	15
Cx00-062 00440A	3	44	11	15	58	15	20
Cx00-072 00610A	3	61	15	20	75	18.5	25
Cx00-072 00750A	3	75	18.5	25	94	22	30
Cx00-072 00830A	3	83	22	30	117	30	40
Cx00-082 01160A	3	116	30	40	149	37	50
Cx00-082 01320A	3	132	37	50	180	45	60
Cx00-092 01760A	3	176	45	60	216	55	75
Cx00-092 02190A	3	219	55	75	266	75	100
Cx00-092 01760E	3	176	45	60	216	55	75
Cx00-092 01760E	3	219	55	75	266	75	100

380/480 Vac ±10%

Order Code	Supply Phases	Heavy Duty			Normal Duty		
		Max Cont. Current (A)	Motor Power (kW)	Motor Power (HP)	Max Cont. Current (A)	Motor Power (kW)	Motor Power (HP)
Cx00-024 00013A	3	1.3	0.37	0.5	For Normal Duty applications, use Heavy Duty ratings.		
Cx00-024 00018A	3	1.8	0.55	0.75			
Cx00-024 00023A	3	2.3	0.75	1			
Cx00-024 00032A	3	3.2	1.1	1.5			
Cx00-024 00041A	3	4.1	1.5	2			
Cx00-034 00056A	3	5.6	2.2	3			
Cx00-034 00073A	3	7.3	3	3			
Cx00-034 00094A	3	9.4	4	5			
Cx00-044 00135A	3	13.5	5.5	7.5			
Cx00-044 00170A	3	17	7.5	10			
Cx00-054 00270A	3	27	11	20	30	15	20
Cx00-054 00300A	3	30	15	20	31	15	20
Cx00-06400350A	3	35	15	25	38	18.5	25
Cx00-064 00420A	3	42	18.5	30	48	22	30
Cx00-064 00470A	3	47	22	30	63	30	50
Cx00-074 00660A	3	66	30	50	79	37	60
Cx00-074 00770A	3	77	37	60	94	45	75
Cx00-074 01000A	3	100	45	75	112	55	75
Cx00-084 01340A	3	134	55	100	155	75	100
Cx00-084 01570A	3	157	75	125	184	90	125
Cx00-094 02000A	3	200	90	150	221	110	150
Cx00-094 02240A	3	224	110	150	266	132	200
Cx00-094 02000E	3	200	90	150	221	110	150
Cx00-094 02240E	3	224	110	150	266	132	200

Accessories: Ordering guide

Optional keypad		Order code
Remote Keypad		8250000000001
Remote keypad RTC		82400000019600

Optional accessories		Order code
AI-Back-up Adaptor		82500000000004
AI-485 Adaptor		82500000000003
AI-Smart Adaptor		82500000018500
RS485 cable		4500-0096
AI-485 24 V Adaptor		82500000019700

Option modules (available from frame size 2 and upwards)		Order code
SI-EtherCAT		82400000018000
SI-PROFIBUS		82400000017500
SI-Ethernet		82400000017900
SI-DeviceNet		82400000017700
SI-CANopen		82400000017600
SI-PROFINET		82400000018200
SI-I/O		82400000017800

Through hole IP65 kit*	
Frame size	Order code
5	3470-0067
6	3470-0055
7	3470-0079
8	3470-0083
9A	3470-0119
9E	3470-0105

Finger-guard grommet	
Frame size	Order code
9A / 9E	3470-0107

Line reactor	
Frame size	Order code
9E (400 V)	7022-0063

Lifting tool	
Frame size	Order code
9A	7778-0045
9E	7778-0016

Fan replacement kit	
Frame size	Order code
1	3470-0092
2	3470-0095
3	3470-0099
4	3470-0103

UL Type 1 Conduit kit	
Frame size	Order code
1	3470-0091
2	3470-0094
3	3470-0098
4	3470-0102
5	3470-0069
6	3470-0059
7	3470-0080
8 / 9A	3470-0088
9E	3470-0115

Retrofit mounting brackets**	
Frame size	Order code
3	3470-0097
4	3470-0101
5	3470-0066
6	3470-0074
7	3470-0078
8	3470-0087
9A / 9E	3470-0118

*IP65 / UL TYPE 12 rating is achieved on the rear of the drive when through panel mounted using the following kits.

**These mounting brackets ensure the drive can be mounted on existing Commander SK installations.

Optional external EMC filters ♦				
Frame size	Voltage	Phases	Type	Order code
1	All	1	Standard	4200-1000
		1	Low leakage	4200-1001
2	100 V	1	Standard	4200-2000
		1	Standard	4200-2001
	200 V	1	Low leakage	4200-2002
		3	Standard	4200-2003
		3	Low leakage	4200-2004
		3	Standard	4200-2005
400 V	3	Standard	4200-2005	
	3	Low leakage	4200-2006	
3	200 V	1	Standard	4200-3000
		1	Low leakage	4200-3001
		3	Standard	4200-3004
	400 V	3	Low leakage	4200-3005
		3	Standard	4200-3008
		3	Low leakage	4200-3009
4	200 V	1	Standard	4200-4000
		1	Low leakage	4200-4001
		3	Standard	4200-4002
	400 V	3	Low leakage	4200-4003
		3	Standard	4200-4004
		3	Low leakage	4200-4005
5	200 V	3	Standard	4200-0312
	400 V	3	Standard	4200-0402
6	200 V	3	Standard	4200-2300
	400 V	3	Standard	4200-4800
7	200 V & 400V	3	Standard	4200-1132
8	200 V & 400V	3	Standard	4200-1972
9	200 V & 400V	3	Standard	4200-3021

♦ Commander C built-in EMC filter complies with EN/IEC 61800-3. External EMC filters are required for compliance with EN/IEC 61000-6-4 as per the table below.

CONTROLTM TECHNIQUES



1,000+
OEM
CUSTOMERS



5M+
INSTALLED
DRIVES



1,000+
EMPLOYEES
WORLDWIDE



70
COUNTRIES

DRIVE SPECIALISTS SINCE 1973

Drives: they're what we do. Whether you're designing a new machine or installing a replacement, we know you need quick delivery and an easy set up, with the confidence that your drive's going to keep on performing with accurate control.

So leave it to the specialists. We've dedicated ourselves to designing and manufacturing variable speed drives since 1973. This means quick set up, high reliability, maximum motor control and fast, efficient service.



Outstanding performance

The outstanding performance of our drives is the fruit of over 45 years of engineering experience in drive design.



Technology you can rely on

Robust design and the highest build quality ensure the enduring reliability of the millions of drives installed around the world.

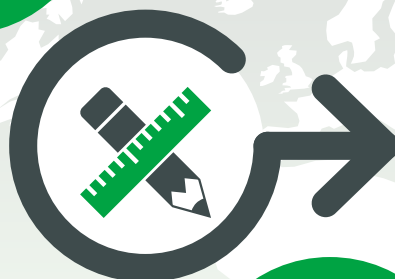

Open design architecture

Based on open design architecture, our drives integrate with all primary communication protocols.



Embedded intelligence

Precision motor control is combined with the highest embedded intelligence, ensuring maximum productivity and efficiency of your machinery.

Global reach, local support

Highly experienced, locally based Application Engineers design and support drive technology to provide maximum value, wherever you are in the world.

A part of the Nidec Group

Connect with us at:



www.controltechniques.com

Control Techniques is your global drives specialist.

With operations in over 70 countries, we're open for business wherever you are in the world.

For more information, or to find your local drive centre representatives, visit

www.controltechniques.com



© 2018 Nidec Control Techniques Limited. The information contained in this brochure is for guidance only and does not form part of any contract. The accuracy cannot be guaranteed as Nidec Control Techniques Ltd have an ongoing process of development and reserve the right to change the specification of their products without notice.

Nidec Control Techniques Limited. Registered Office: The Gro, Newtown, Powys SY16 3BE. Registered in England and Wales. Company Reg. No. 01236886.