

A-5-1.2 VH Series

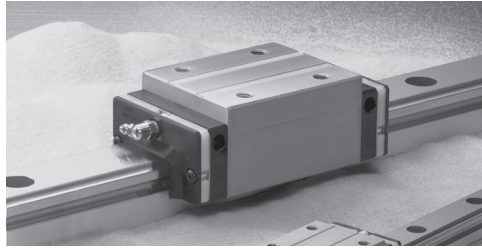

1. Features

(1) High-performance end seals

High-performance end seals with a multi-lip structure prevent the entry of various foreign matters.

(2) NSK K1™ lubrication unit (standard)

Outstanding lubrication support of NSK K1 further improves sealing capability and durability. Additional NSK K1 units can be mounted for specific usage conditions and environments.

(3) Tapped holes on a rail bottom surface (optional)

In addition to standard mounting bolt holes (counterbores on a rail top surface), a specification for tapped holes on a rail bottom surface for enhanced sealing capability is available for the VH Series. (Refer to the dimension table.)

(4) High self-aligning capability (rolling direction)

Same as the DF combination in angular contact bearings, self-aligning capability is high because the cross point of the contact lines of balls and grooves comes inside, reducing moment rigidity.

This increases the capacity to absorb errors in installation.

(5) High load carrying capacity to vertical direction

The contact angle is set at 50 degrees, thus increasing load carrying capacity as well as rigidity in vertical direction.

(6) High resistance against impact load

The bottom ball groove is formed in Gothic arch and the center of the top and bottom grooves are offset as shown in Fig. 2. The vertical load is generally carried by the top rows, at where balls are contacting at two points. Because of this design, the bottom rows will carry load when a large impact load

is applied vertically as shown in Fig. 3. This assures high resistance to the impact load.

(7) High accuracy

As showing in Fig. 4, fixing the master rollers to the ball grooves is easy thanks to the Gothic arch groove. This makes easy and accurate measuring of ball grooves.

(8) Random matching type

Random-matching of rails and ball slides are available.

(9) Improve rating life dramatically

New ball groove geometry is introduced,

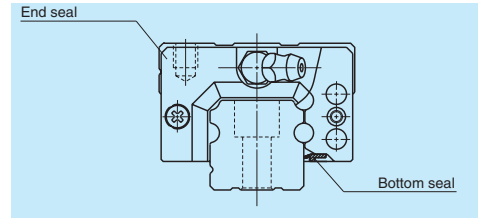

Fig. 1 VH Series

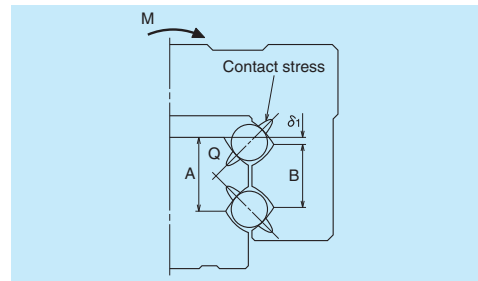

Fig. 2 Enlarged illustration of the offset Gothic arch groove

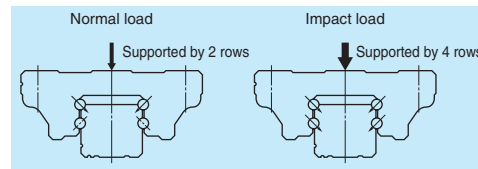

Fig. 3 When load is applied

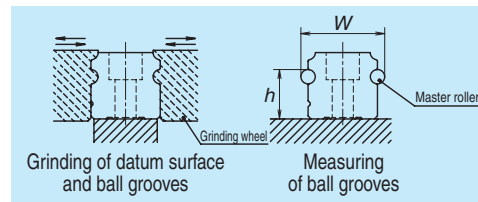

Fig. 4 Rail grinding and measuring

which has been developed by utilizing NSK's state-of-the-art tribological and analytical technologies. Due to the optimized distribution of contact surface pressures, the rating life has dramatically increased. As compared with the conventional products, the load rating capacity has increased to 1.3 times, while the life span has increased to twice^{*1}.

*1: Representative values of series.

● Comparison with NSK standard products

Less than 1/10 the level of fine contaminants
Results of dust-proof tests reveal that the entry of fine contaminants is reduced to less than one-tenth of existing standard series due to improvements in sealing capability.

Test sample : VH30AN
Speed : 16.7 mm/sec
Contaminant : Graphite powder (average grain size: 0.037 mm) + Grease

compared to the standard series, as shown in the graph.

Test sample : VH30AN (preload of 3 200 N)
Rail orientation : Horizontal (wall mount)
Speed : 400 mm/sec
Lubrication : AS2 grease (prepacked AS2 only)
Contaminant : Fine wood particles

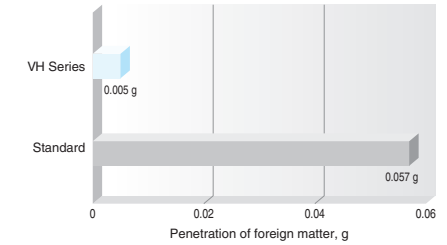

Operating life under contaminated environments is more than 5 times longer

Durability test with rubber fragments

Extreme durability tests under contaminated environments using rubber fragments show that durability of the VH Series extended more than five times longer than the existing standard series, as shown in the graph.

Test sample : VH30AN, preload code Z1 (preload of 245 N)
Rail orientation : Horizontal (wall mount)
Speed : 500 mm/sec
Lubrication : AS2 grease (prepacked AS2 only)
Contaminant : Rubber fragments

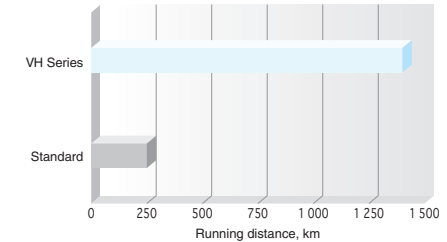

Durability test with fine wood particles

Extreme durability tests in a contaminated environment with fine wood particles show that durability of the VH Series is more than doubled

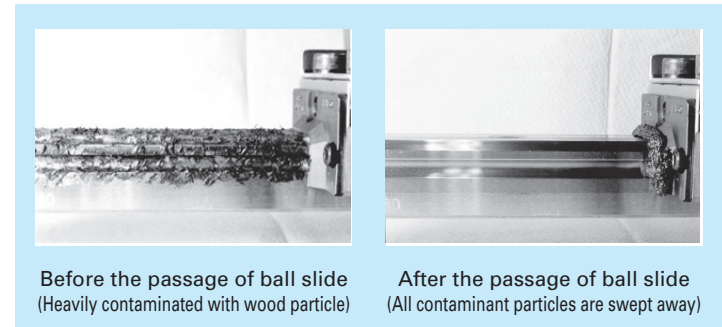
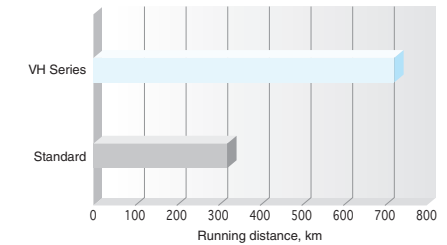

Before the passage of ball slide (Heavily contaminated with wood particle)

After the passage of ball slide (All contaminant particles are swept away)

The data shown in the catalog are the results of our tests, and no warranty is given to sealing performance on actual usage on machinery. Sealing performance is affected by usage environment and lubrication conditions. Dust covers and other measures to keep machinery free of dust are recommended.

2. Ball slide shape

Ball slide Model	Shape/installation method	Type (Upper row, Rating: Lower row, Ball slide length)	
		High-load type Standard	Super-high-load type Long
AN BN		AN	BN
AL BL		AL	BL
EM GM		EM	GM

3. Accuracy and preload

(1) Running parallelism of ball slide

Table 1

Unit: μm

Rail length (mm) over or less	Preloaded assembly (not random matching)					Random-matching type
	Ultra precision K3	Super precision K4	High precision K5	Precision grade K6	Normal grade KN	Normal grade KC
– 50	2	2	2	4.5	6	6
50 – 80	2	2	3	5	6	6
80 – 125	2	2	3.5	5.5	6.5	6.5
125 – 200	2	2	4	6	7	7
200 – 250	2	2.5	5	7	8	8
250 – 315	2	2.5	5	8	9	9
315 – 400	2	3	6	9	11	11
400 – 500	2	3	6	10	12	12
500 – 630	2	3.5	7	12	14	14
630 – 800	2	4.5	8	14	16	16
800 – 1 000	2.5	5	9	16	18	18
1 000 – 1 250	3	6	10	17	20	20
1 250 – 1 600	4	7	11	19	23	23
1 600 – 2 000	4.5	8	13	21	26	26
2 000 – 2 500	5	10	15	22	29	29
2 500 – 3 150	6	11	17	25	32	32
3 150 – 4 000	9	16	23	30	34	34

(2) Accuracy standard

The preloaded assembly has five accuracy grades; Ultra precision K3, Super precision K4, High precision K5, Precision K6, and Normal KN grades, while the random-matching type has Normal KC grade only.

• Tolerance of preloaded assembly

Table 2

Unit: μm

Characteristics	Accuracy grade	Ultra precision K3	Super precision K4	High precision K5	Precision grade K6	Normal grade KN
Mounting height H Variation of H (All ball slides on a set of rails)		± 10 3	± 10 5	± 20 7	± 40 15	± 80 25
Mounting width W_2 or W_3 Variation of W_2 or W_3 (All ball slides on reference rail)		± 15 3	± 15 7	± 25 10	± 50 20	± 100 30
Running parallelism of surface C to surface A Running parallelism of surface D to surface B		Shown in Table 1, Fig. 5 and Fig. 6				

• Tolerance of random-matching type: Normal grade KC

Table 3

Unit: μm

Model No.	VH15, 20, 25, 30, 35	VH45, 55
Characteristics		
Mounting height H	± 20	± 30
Variation of mounting height H	15① 30②	20① 35②
Mounting width W_2 or W_3	± 30	± 35
Variation of mounting width W_2 or W_3	25	30
Running parallelism of surface C to surface A Running parallelism of surface D to surface B	See Table 1, Fig. 5 and Fig. 6	

Note: ① Variation on the same rail ② Variation on multiple rails

(3) Combinations of accuracy and preload

Table 4

		Accuracy grade					
		Ultra precision	Super precision	High Precision	Precision grade	Normal grade	Normal grade
With NSK K1 lubrication unit		K3	K4	K5	K6	KN	KC
Preload	Fine clearance Z0	○	○	○	○	○	—
	Slight preload Z1	○	○	○	○	○	—
	Medium preload Z3	○	○	○	○	—	—
	Random-matching type with fine clearance ZT	—	—	—	—	—	○
	Random-matching type with slight preload ZZ	—	—	—	—	—	○

(4) Assembled accuracy

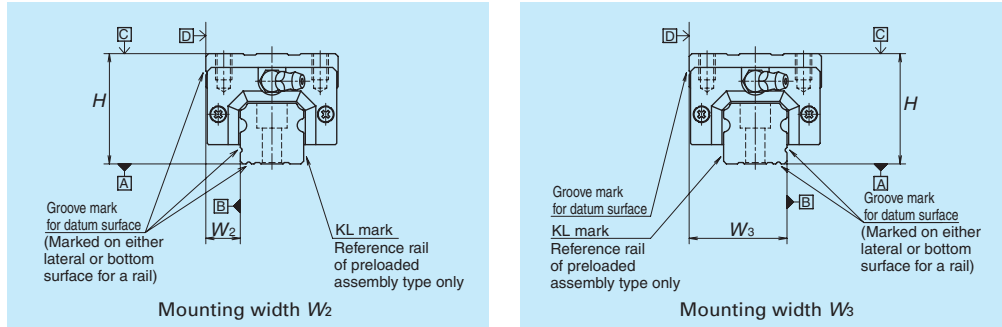

Fig. 5 Special high carbon steel

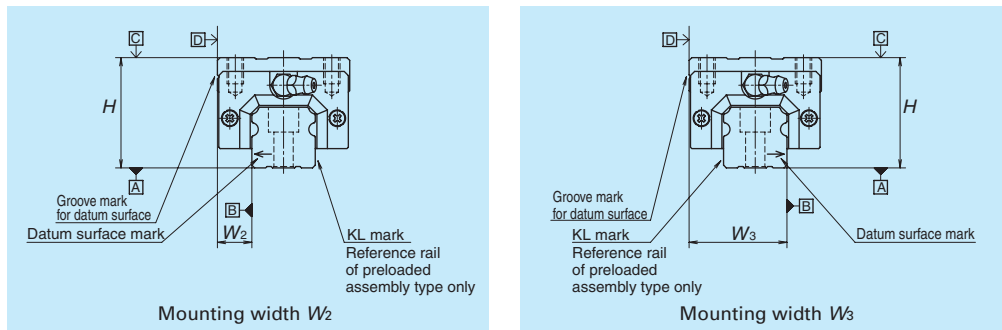

Fig. 6 Stainless steel

(5) Preload and rigidity

We offer five levels of preload: Slight preload Z1, Medium preload Z3 and Fine clearance Z0, along with random-matching type of Fine clearance ZT and Slight preload ZZ.

• Preload and rigidity of preloaded assembly

Table 5

Model No.		Preload (N)		Rigidity (N/μm)			
		Slight preload Z1		Vertical direction		Lateral direction	
				Medium preload Z3	Slight preload Z1	Medium preload Z3	Slight preload Z1
High-load type	VH15 AN, EM	78	490	137	226	98	186
	VH20 AN, EM	147	835	186	335	137	245
	VH25 AN, AL, EM	196	1 270	206	380	147	284
	VH30 AN, AL	245	1 570	216	400	157	294
	VH30 EM	294	1 770	265	480	186	355
	VH35 AN, AL, EM	390	2 350	305	560	216	390
	VH45 AN, AL, EM	635	3 900	400	745	284	540
Super-high-load type	VH55 AN, AL, EM	980	5 900	490	910	345	645
	VH15 BN, GM	98	685	196	345	137	284
	VH20 BN, GM	196	1 080	265	480	196	355
	VH25 BN, BL, GM	245	1 570	294	560	216	400
	VH30 BN, BL, GM	390	2 260	360	665	265	480
	VH35 BN, BL, GM	490	2 940	430	795	305	570
	VH45 BN, BL, GM	785	4 800	520	960	370	695
	VH55 BN, BL, GM	1 180	7 050	635	1 170	440	835

Note: Clearance for Fine clearance Z0 is 0 to 3 μm. Therefore, preload is zero.

However, Z0 of PN grade is 0 to 15 μm.

• Preload of random-matching type

Table 6

Unit: μm

Model No.	Fine clearance ZT	Slight preload ZZ
	VH15	-4 - 15
VH20	-5 - 15	-5 - 0
VH25		-5 - 0
VH30		-7 - 0
VH35		-7 - 0
VH45		-7 - 0
VH55		-9 - 0

Note: Minus sign denotes that a value is an amount of preload (elastic deformation of balls).

4. Maximum rail length

Table 7 shows the limitations of rail length (maximum length). However, the limitations vary by accuracy grade.

Table 7 Length limitations of rails

Unit: mm

Series	Size	15	20	25	30	35	45	55
	Material							
VH	Special high carbon steel	2 000	3 960	3 960	4 000	4 000	3 990	3 960
	Stainless steel	1 800	3 500	3 500	3 500			

Note: Rails can be butted if user requirement exceeds the rail length shown in the table. Please consult NSK.

5. Installation

(1) Permissible values of mounting error

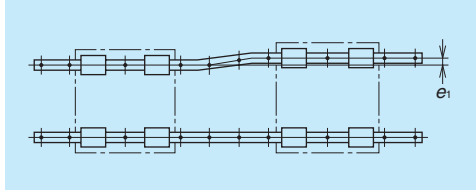

Fig. 7

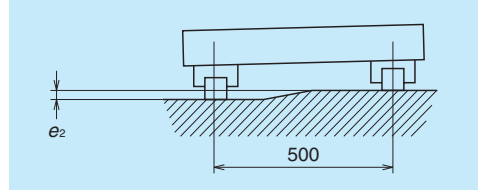

Fig. 8

Table 8

Unit: μm

Value	Preload	Model No.						
		VH15	VH20	VH25	VH30	VH35	VH45	VH55
Permissible values of parallelism in two rails e_1	Z0, ZT	22	30	40	45	55	65	80
	Z1, ZZ	18	20	25	30	35	45	55
	Z3	13	15	20	25	30	40	45
Permissible values of parallelism (height) in two rails e_2	Z0, ZT	375 μm /500 mm						
	Z1, ZZ, Z3	330 μm /500 mm						

(2) Shoulder height of the mounting surface and corner radius r

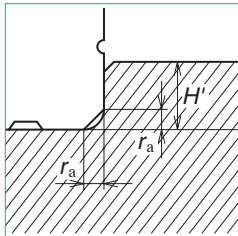

Fig. 9 Shoulder for the rail datum surface

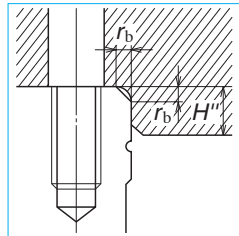

Fig. 10 Shoulder for the ball slide datum surface

Table 9

Unit: mm

Model No.	Corner radius (maximum)		Shoulder height	
	r_a	r_b	H'	H''
VH15	0.5	0.5	4	4
VH20	0.5	0.5	4.5	5
VH25	0.5	0.5	5	5
VH30	0.5	0.5	6	6
VH35	0.5	0.5	6	6
VH45	0.7	0.7	8	8
VH55	0.7	0.7	10	10

(3) Specification for tapped holes on a rail bottom surface

- Special high carbon steel is available for this specification.
- Applicable accuracy grades are precision grade (K6) and normal grades (KN and KC) only.
- The minimum rail length for production is 400 mm.
- The tapping pitch is the same as the pitch for regular mounting bolt holes. Please refer to the dimension table.

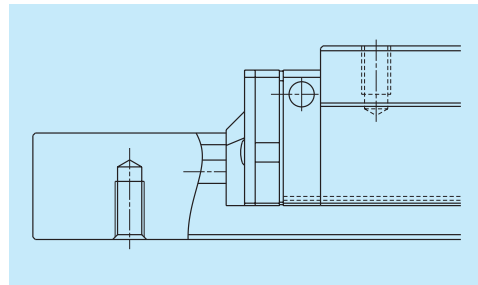

Fig. 11

6. Lubrication components

Refer to pages A38 and D13 for the lubrication of linear guides.

(1) Types of lubrication accessories

Fig. 12 and Table 10 show grease fittings and tube fittings.

We provide lubrication accessories with extended thread body length (L) for the addition of dust-proof accessories such as NSK K1 lubrication unit, double seal and protector.

We provide a suitable lubrication accessory for the special requirement on dust-proof accessories.

Consult NSK for a lubrication accessory with extended length of thread body for your convenience of replenishing lubricant.

Please ask NSK for stainless lubrication accessories.

(2) Mounting position of lubrication accessories

The standard position of grease fittings is the end face of ball slide. We mount them on a side of end cap for an option. (Fig. 13)

Please consult NSK for installation of grease or tube fittings to the ball slide body or side of end cap.

When using a piping unit with thread of M6 \times 1, you require a connector to connect to a grease fitting mounting hole with M6 \times 0.75. The connector is available from NSK.

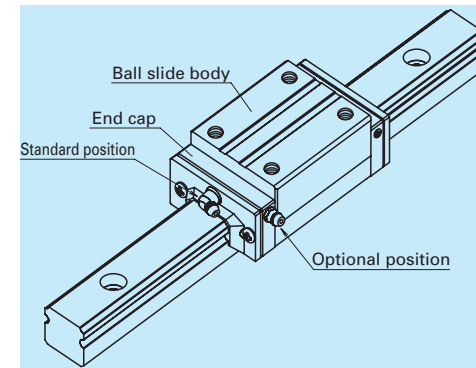
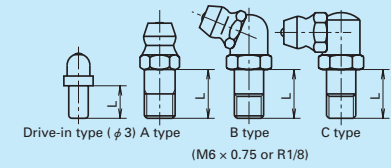

Fig. 13 Mounting position of lubrication accessories

Grease fitting



Tube fitting

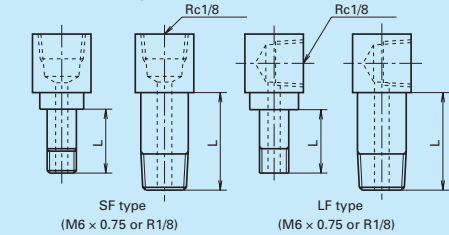

Fig. 12 Grease fitting and tube fitting

Table 10

Unit: mm

Model No.	Dust-proof specification	Dimension L		
		Grease fitting / Drive-in type	Tube fitting	
			SF type	LF type
VH15	Standard*	10	-	-
	Double seal	**	-	-
	Protector	**	-	-
VH20	Standard*	12	-	-
	Double seal	18	-	-
	Protector	18	-	-
VH25	Standard*	12	15	16
	Double seal	18	23	24.5***
	Protector	18	17	18
VH30	Standard*	14	18	17.5
	Double seal	22	25	24.5
	Protector	22	19.5	19
VH35	Standard*	14	15	15
	Double seal	22	25	24.5
	Protector	22	21.5	22
VH45	Standard*	18	22	21.5
	Double seal	22	32	32
	Protector	28	28	30
VH55	Standard*	18	20	20
	Double seal	22	32	32
	Protector	28	28	30

*) NSK K1 units are mounted as a standard specification for VH series.

**) A connector is required for grease fitting. Please contact NSK.

***) Only available for AN and BN type ball slides.

7. Dust-proof components

(1) Standard specification

To keep foreign matters from entering inside the ball slide, VH Series has an end seal on both ends, and bottom seals at the bottom. Two NSK K1, one at each end, are installed as the standard equipment.

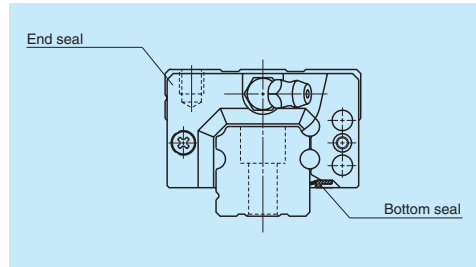

Fig. 14

Table 11 Seal friction per ball slide (maximum value)

Series	Size	Unit: N						
		15	20	25	30	35	45	55
VH		11	13	14	17	23	33	44

(2) Double seal and protector

For VH Series, double-seal and protector can be installed only before shipping from the factory. Please consult NSK when you require them.

Table 12 shows the ball slide length when a double seal set and a protector are installed.

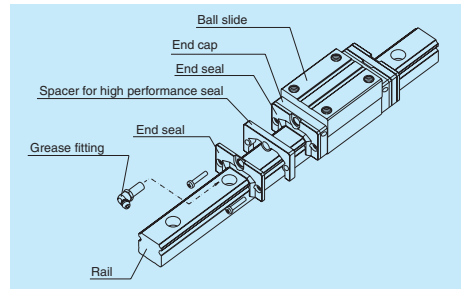

Fig. 15 Double seal

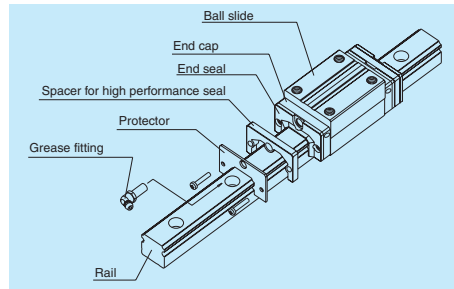

Fig. 16 Protector

Table 12 Dimension of installing dust-proof optional components

Unit: mm

Model No.	Ball slide length	Ball slide model	Ball slide length L		
			Standard	Double seal installation	Protector installation
VH15	Standard type	AN, EM	70.6	81.6	77
	Long type	BN, GM	89.6	100.6	96
VH20	Standard type	AN, EM	87.4	100.4	94.2
	Long type	BN, GM	109.4	122.4	116.2
VH25	Standard type	AN, AL, EM	97	110	104.4
	Long type	BN, BL, GM	125	138	132.4
VH30	Standard type	AN, AL, EM	104.4	120.4	114.8
	Long type	BN, BL, GM	143.4	159.4	153.8
VH35	Standard type	AN, AL, EM	128.8	144.8	139.2
	Long type	BN, BL, GM	162.8	178.8	173.2
VH45	Standard type	AN, AL, EM	161.4	180.4	174.2
	Long type	BN, BL, GM	193.4	212.4	206.2
VH55	Standard type	AN, AL, EM	185.4	204.4	198.2
	Long type	BN, BL, GM	223.4	242.4	236.2

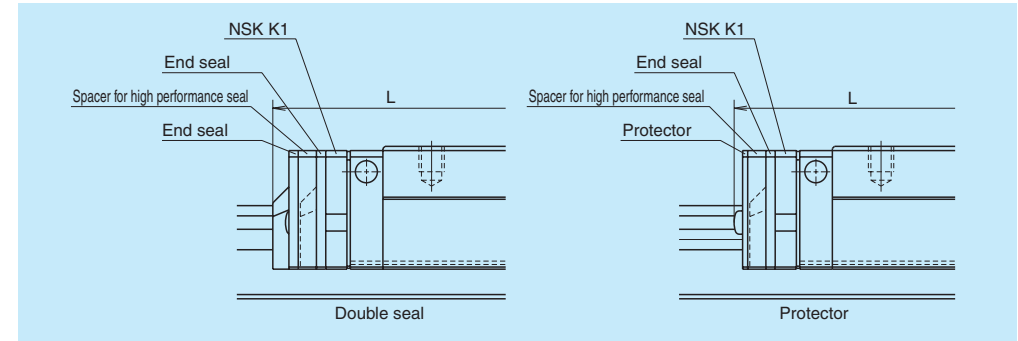

Fig. 17

(3) Cap to plug the rail mounting bolt hole

Table 13 Caps to plug rail bolt hole

Model No.	Bolt to secure rail	Cap reference No.	Quantity /case
VH15	M4	LG-CAP/M4	20
VH20	M5	LG-CAP/M5	20
VH25	M6	LG-CAP/M6	20
VH30, VH35	M8	LG-CAP/M8	20
VH45	M12	LG-CAP/M12	20
VH55	M14	LG-CAP/M14	20

(4) Inner seal

The availability of inner seal is limited to the models shown below.

Table 14

Series	Model No.
VH	VH20, VH25, VH30, VH45, VH55

8. Design Precautions

Because the product is used under severe operating conditions that require high performance end seals, please inform NSK about your service conditions using the technical data sheet on page A152.

8. Reference number

Reference numbers shall be set to individual NSK linear guide when its specifications are finalized, and it is indicated on its specification drawing.
Please specify the reference number, except design serial number, to identify the product when ordering, requiring estimates, or inquiring about specifications from NSK.

(1) Reference number for preloaded assembly

VH 30 1000 ANC 2 - K5 3**

Series name					
Size					Preload code (See page A137.)
Rail length (mm)					Accuracy code (See Table 16.)
Ball slide shape code (See page A135.)					Design serial number
Material/surface treatment code (See Table 15.)					Number of ball slides per rail

0: Z0, 1: Z1, 3: Z3
C: Special high carbon steel (NSK standard), K: Stainless steel
Added to the reference number.

(2) Reference number for random-matching type

VAH 30 ANC -KCZ**

Random-matching ball slide series code					
Size					Preload code
Ball slide shape code (See page A135.)					Accuracy code: KC
Material/surface treatment code (See Table 15.)					Design serial number

VAH: VH Series random-matching ball slide
T: Fine clearance. Z: Slight preload (See page A137.)
KC: Normal grade is only available.
Added to the reference number.

Rail
V1H30 1000 L CN - PC Z**

Random-matching rail series code					
Size					Preload code (See page A137.)
Rail length (mm)					Accuracy code: PC
Rail shape code: L					Design serial number
Material/surface treatment code (See Table 15.)					*Butting rail specification

V1H: VH Series random-matching rail
L: Standard
N: Non-butting. L: Butting specification
T: Fine clearance. Z: Slight preload
PC: Normal grade is only available.
*Please consult with NSK for butting rail specification.

The reference number coding for the assembly of random-matching type is the same as that of preloaded assembly. However, the preload code of "fine clearance T" and "slight preload Z" is only applicable (refer to page A137).

Table 15 Material/surface treatment code

Code	Description
C	Special high carbon steel (NSK standard) + counterbores on a rail top surface
K	Stainless steel + counterbores on a rail top surface
D	Special high carbon steel with surface treatment + counterbores on a rail top surface
H	Stainless steel with surface treatment + counterbores on a rail top surface
V	Special high carbon steel (NSK standard) + tapped holes on a rail bottom surface
W	Special high carbon steel with surface treatment + tapped holes on a rail bottom surface
Z	Other, special

Table 16 Accuracy code

Accuracy	Standard (with NSK K1)
Ultra precision grade	K3
Super precision grade	K4
High precision grade	K5
Precision grade	K6
Normal grade	KN
Normal grade (random-matching type)	KC

Note: Refer to page A38 for NSK K1 lubrication unit.

9. Dimensions
VH-AN (High-load type / Standard)
VH-BN (Super-high-load type/ Long)

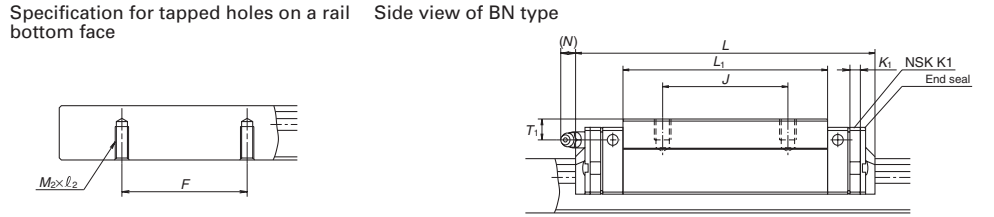
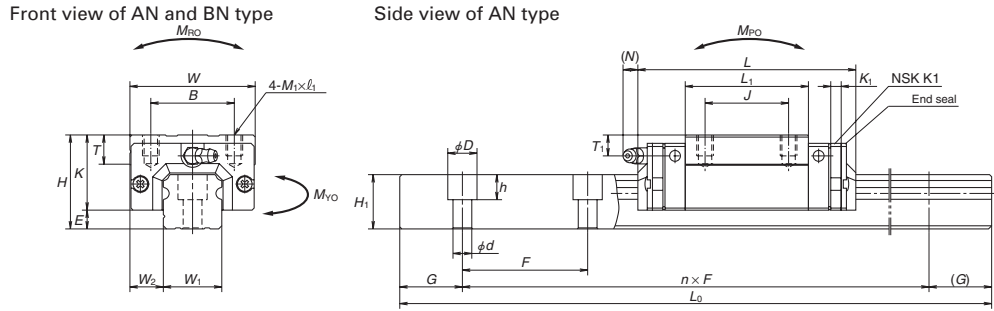
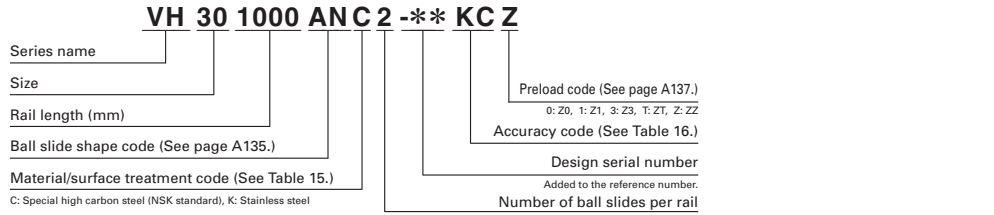

Model No.	Assembly		Ball slide											Width	Height		
	Height	E	Width	Length	Mounting hole			Grease fitting					Width			Height	
					B	J	M x pitch x l	L1	K	T	K1	Hole size					T1
VH15AN VH15BN	28	4.6	9.5	34	70.6 (77) 89.6 (96)	26	26	M4x0.7x6	39 58	23.4	8	4.5	phi 3	8.5	1 (8.2)	15	15
VH20AN VH20BN	30	5	12	44	87.4 (94.2) 109.4 (116.2)	32	36	M5x0.8x6	50 72	25	12	4.5	M6x0.75	5	11.1 (12.3)	20	18
VH25AN VH25BN	40	7	12.5	48	97 (104.4) 125 (132.4)	35	35	M6x1x9	58 86	33	12	5	M6x0.75	10	9.6 (12.9)	23	22
VH30AN VH30BN	45	9	16	60	104.4 (114.8) 143.4 (153.8)	40	40	M8x1.25x10	59 98	36	14	5	M6x0.75	10	11.4 (14.2)	28	26
VH35AN VH35BN	55	9.5	18	70	128.8 (139.2) 162.8 (173.2)	50	50	M8x1.25x12	80 114	45.5	15	5.5	M6x0.75	15	10.9 (13.7)	34	29
VH45AN VH45BN	70	14	20.5	86	161.4 (174.2) 193.4 (206.2)	60	60	M10x1.5x17	105 137	56	17	6.5	Rc1/8	20	12.5 (14.1)	45	38
VH55AN VH55BN	80	15	23.5	100	185.4 (198.2) 223.4 (236.2)	75	75	M12x1.75x18	126 164	65	18	6.5	Rc1/8	21	12.5 (14.1)	53	44

Notes: 1) Figure inside () is the dimension when equipped with the protector.
 2) VH Series does not have a ball retainer. Be aware that balls fall out when the ball slide is withdrawn from the rail.
 3) External appearance of stainless steel ball slides differs from those of carbon steel ball slides.

Reference number for ball slide of random-matching type

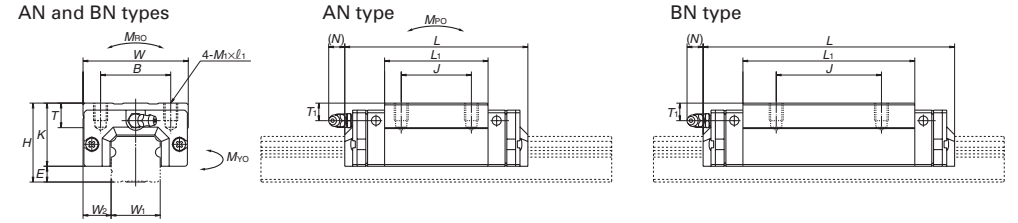
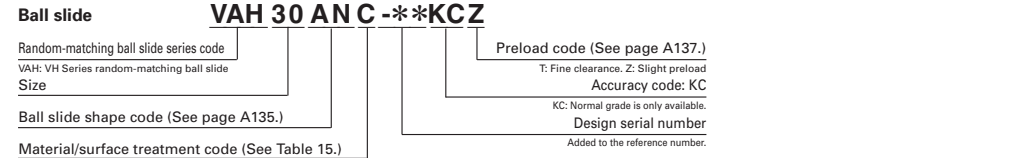

Reference number for rail of random-matching type

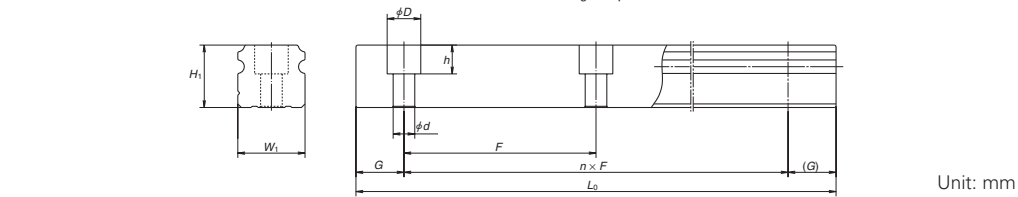
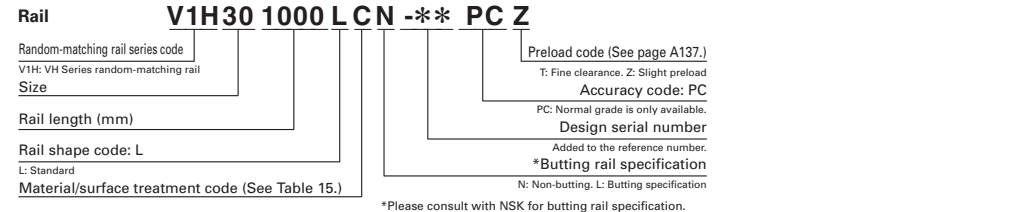

Rail			Basic load rating										Weight	
Pitch	Mounting bolt hole	Tapped hole	G	Max. length L _{0max} (mm) for stainless	Dynamic		Static	M _{RO}	Static moment (N-m)				Ball slide (kg)	Rail (kg/m)
					[50km] C ₅₀ (N)	[100km] C ₁₀₀ (N)			C ₀ (N)	M _{RO}	M _{PO}			
F	d x D x h	M ₂ x pitch x l ₂	(reference)					One slide			Two slides	One slide	Two slides	
60	4.5x7.5x5.3	M5x0.8x8	20	2 000 [1 800]	14 200 18 100	11 300 14 400	20 700 32 000	108 166	94.5 216	575 1 150	79.5 181	480 965	0.18 0.26	1.6
60	6x9.5x8.5	M6x1x10	20	3 960 [3 500]	23 700 30 000	18 800 24 000	32 500 50 500	219 340	185 420	1 140 2 230	155 355	955 1 870	0.33 0.48	2.6
60	7x11x9	M6x1x12	20	3 960 [3 500]	33 500 45 500	26 800 36 500	46 000 71 000	360 555	320 725	1 840 3 700	267 610	1 540 3 100	0.55 0.82	3.6
80	9x14x12	M8x1.25x15	20	4 000 [3 500]	41 000 61 000	32 500 48 500	51 500 91 500	490 870	350 1 030	2 290 5 600	292 865	1 920 4 700	0.77 1.3	5.2
80	9x14x12	M8x1.25x17	20	4 000	62 500 81 000	49 500 64 500	80 500 117 000	950 1 380	755 1 530	4 500 8 350	630 1 280	3 800 7 000	1.5 2.1	7.2
105	14x20x17	M12x1.75x24	22.5	3 990	107 000 131 000	84 500 104 000	140 000 187 000	2 140 2 860	1 740 3 000	9 750 15 600	1 460 2 520	8 150 13 100	3.0 3.9	12.3
120	16x23x20	M14x2x24	30	3 960	158 000 193 000	125 000 153 000	198 000 264 000	3 600 4 850	3 000 5 150	16 300 26 300	2 510 4 350	13 700 22 100	4.7 6.1	16.9

4) The basic load rating comply with the ISO standard. (ISO 14728-1, 14728-2)
 C₅₀: the basic dynamic load rating for 50 km rated fatigue life C₁₀₀: the basic dynamic load rating for 100 km rated fatigue life
 The basic static load rating shows static permissible load.

VH-AL (High-load type / Standard)
VH-BL (Super-high-load type / Long)

VH 30 1000 AL C 2 -** KC Z

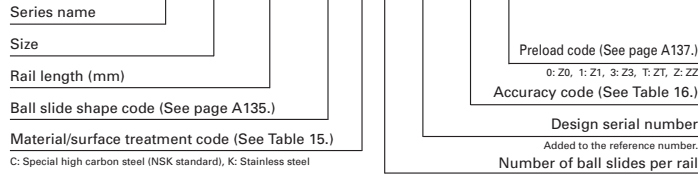

Front view of AL and BL type

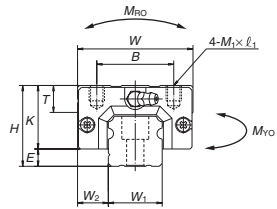

Side view of AL type

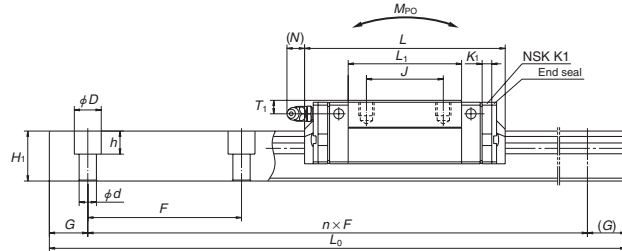

Specification for tapped holes on a rail bottom face

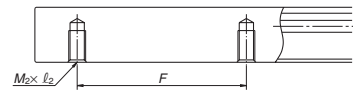

Side view of BL type

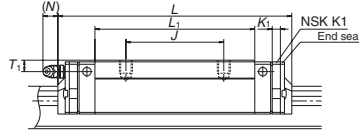

Model No.	Assembly		Ball slide											Width	Height		
	Height	Length	Width	Mounting hole			Grease fitting					Width	Height				
				H	E	W ₂	W	L	B	J	M x pitch x l					L ₁	K
VH25AL VH25BL	36	7	12.5	48	97 (104.4) 125 (132.4)	35	35 50	M6x1x6	58 86	29	12	5	M6x0.75	6	9.6 (12.9)	23	22
VH30AL VH30BL	42	9	16	60	104.4 (114.8) 143.4 (153.8)	40	40 60	M8x1.25x8	59 98	33	14	5	M6x0.75	7	11.4 (14.2)	28	26
VH35AL VH35BL	48	9.5	18	70	128.8 (139.2) 162.8 (173.2)	50	50 72	M8x1.25x8	80 114	38.5	15	5.5	M6x0.75	8	10.9 (13.7)	34	29
VH45AL VH45BL	60	14	20.5	86	161.4 (174.8) 193.4 (206.2)	60	60 80	M10x1.5x10	105 137	46	17	6.5	Rc1/8	10	12.5 (14.1)	45	38
VH55AL VH55BL	70	15	23.5	100	185.4 (198.2) 223.4 (236.2)	75	75 95	M12x1.75x13	126 164	55	15	6.5	Rc1/8	11	12.5 (14.1)	53	44

Notes: 1) Figure inside () is the dimension when equipped with the protector.

2) VH Series does not have a ball retainer. Be aware that balls fall out when the ball slide is withdrawn from the rail.

3) External appearance of stainless steel ball slides differs from those of carbon steel ball slides.

Reference number for ball slide of random-matching type

Ball slide

VAH 30 AL C -** KC Z

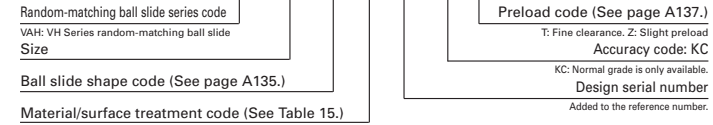

AL and BL types

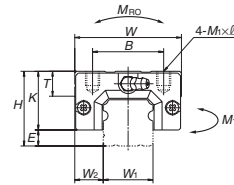

AL type

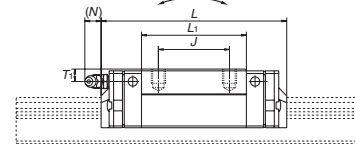

BL type

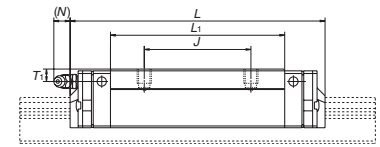

Reference number for rail of random-matching type

Rail

V1H30 1000 L CN -** PC Z

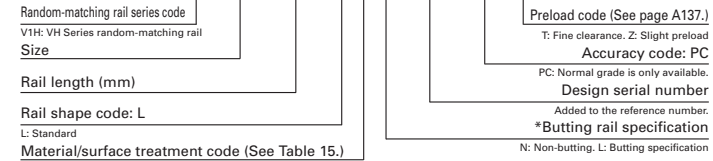

*Please consult with NSK for butting rail specification.

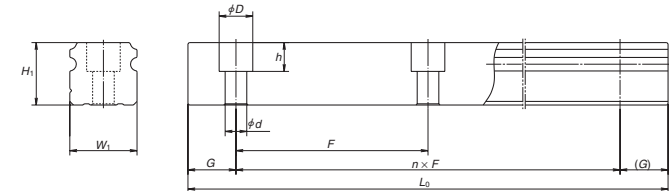

Rail			Basic load rating							Weight				
Pitch	Mounting bolt hole	Tapped hole	G	Max. length L _{0max} (mm) for stainless	Dynamic		Static	Static moment (N-m)				Ball slide (kg)	Rail (kg/m)	
					C ₅₀ (N)			C ₀ (N)	M _{P0}		M _{Y0}			
					[50km]	[100km]			One slide	Two slides	One slide			Two slides
60	7x11x9	M6x1x12	20	3 960 [3 500]	33 500 45 500	26 800 36 500	46 000 71 000	360 555	320 725	1 840 3 700	267 610	1 540 3 100	0.46 0.69	3.6
80	9x14x12	M8x1.25x15	20	4 000 [3 500]	41 000 61 000	32 500 48 500	51 500 91 500	490 870	350 1 030	2 290 5 600	292 865	1 920 4 700	0.69 1.16	5.2
80	9x14x12	M8x1.25x17	20	4 000	62 500 81 000	49 500 64 500	80 500 117 000	950 1 380	755 1 530	4 500 8 350	630 1 280	3 800 7 000	1.2 1.7	7.2
105	14x20x17	M12x1.75x24	22.5	3 990	107 000 131 000	84 500 104 000	140 000 187 000	2 140 2 860	1 740 3 000	9 750 15 600	1 460 2 520	8 150 13 100	2.2 2.9	12.3
120	16x23x20	M14x2x24	30	3 960	158 000 193 000	125 000 153 000	198 000 264 000	3 600 4 850	3 000 5 150	16 300 26 300	2 510 4 350	13 700 22 100	3.7 4.7	16.9

4) The basic load rating comply with the ISO standard. (ISO 14728-1, 14728-2)

C₅₀: the basic dynamic load rating for 50 km rated fatigue life C₁₀₀: the basic dynamic load rating for 100 km rated fatigue life The basic static load rating shows static permissible load.

VH-EM (High-load type / Standard)
VH-GM (Super-high-load type / Long)

VH 30 1000 EM C 2 -** KC Z

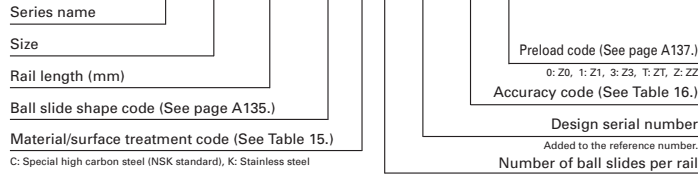

Front view of EM and GM type

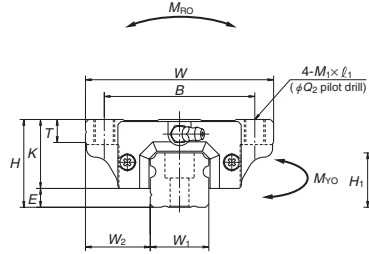

Side view of EM type

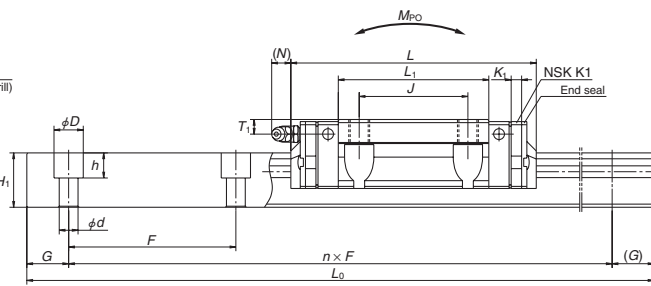

Specification for tapped holes on a rail bottom face

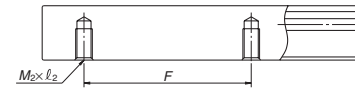

Side view of GM type

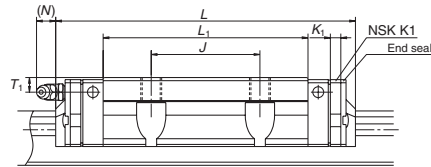

Model No.	Assembly		Ball slide													Width	Height		
	Height	Width	Length	Mounting hole						Grease fitting				Width	Height				
				H	E	W ₂	W	L	B	J	Q ₁ x l ₁	Q ₂	L ₁					K	T
VH15EM	24	4.6	16	47	70.6 (77)	38	30	M5x0.8x7	4.4	39	19.4	8	4.5	phi 3	4.5	1	(8.2)	15	15
VH15GM					89.6 (96)					58									
VH20EM	30	5	21.5	63	87.4 (94.2)	53	40	M6x1x9.5	5.3	50	25	10	4.5	M6x0.75	5	11.1 (12.3)	20	18	
VH20GM					109.4 (116.2)					72									
VH25EM	36	7	23.5	70	97 (104.4)	57	45	M8x1.25x10	6.8	58	29	11	5	M6x0.75	6	9.6 (12.9)	23	22	
VH25GM					125 (132.4)			[M8x1.25x11.5]		86		[12]							
VH30EM	42	9	31	90	117.4 (127.8)	72	52	M10x1.5x12	8.6	72	33	11	5	M6x0.75	7	11.4 (14.2)	28	26	
VH30GM					143.4 (153.8)			[M10x1.5x14.5]		98		[15]							
VH35EM	48	9.5	33	100	128.8 (139.2)	82	62	M10x1.5x13	8.6	80	38.5	12	5.5	M6x0.75	8	10.9 (13.7)	34	29	
VH35GM					162.8 (173.2)					114									
VH45EM	60	14	37.5	120	161.4 (174.2)	100	80	M12x1.75x15	10.5	105	46	13	6.5	Rc1/8	10	12.5 (14.1)	45	38	
VH45GM					193.4 (206.2)					137									
VH55EM	70	15	43.5	140	185.4 (198.2)	116	95	M14x2x18	12.5	126	55	15	6.5	Rc1/8	11	12.5 (14.1)	53	44	
VH55GM					223.4 (236.2)					164									

- Notes: 1) Figure inside () is the dimension when equipped with the protector.
- 2) Figure inside [] is applied to stainless products.
- 3) VH Series does not have a ball retainer. Be aware that balls fall out when the ball slide is withdrawn from the rail.
- 4) External appearance of stainless steel ball slides differs from those of carbon steel ball slides.

Reference number for ball slide of random-matching type

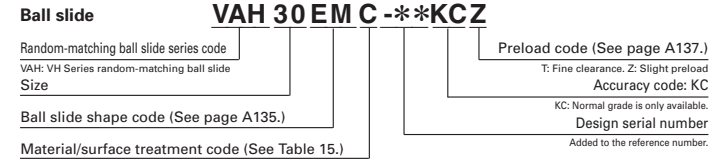

EM and GM types

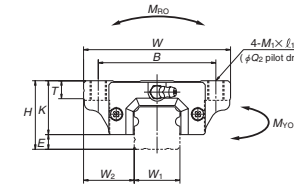

EM type

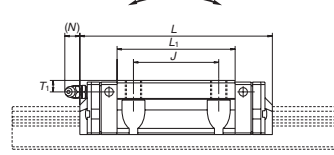

GM type

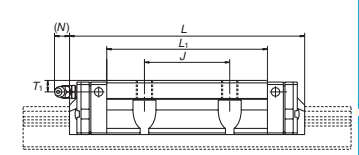

Reference number for rail of random-matching type

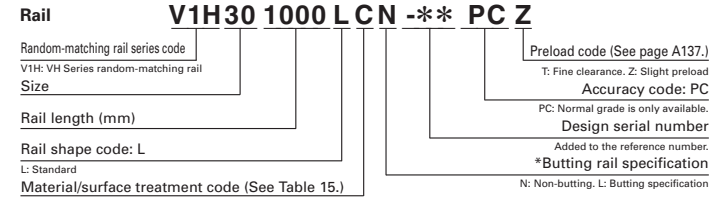

*Please consult with NSK for butting rail specification.

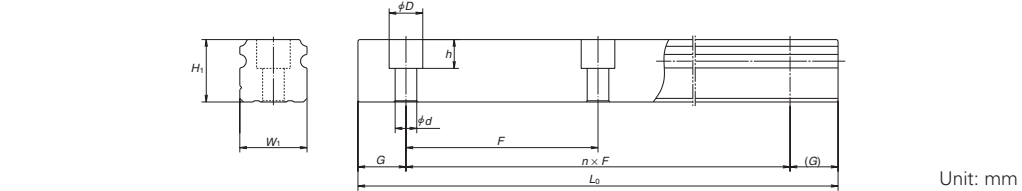

Rail				Basic load rating						Weight				
Pitch	Mounting bolt hole	Tapped hole	G	Max. length L _{0max} () for stainless	Dynamic		Static	Static moment (N-m)				Ball slide (kg)	Rail (kg/m)	
					[50km]	[100km]		C ₀	M _{RO}	M _{PO}				M _{VO}
60	4.5x7.5x5.3	M5x0.8x8	20	2 000 [1 800]	14 200	11 300	20 700	108	94.5	575	79.5	480	0.17	1.6
					18 100	14 400	32 000	166	216	1 150	181	965	0.25	
60	6x9.5x8.5	M6x1x10	20	3 960 [3 500]	23 700	18 800	32 500	219	185	1 140	155	955	0.45	2.6
					30 000	24 000	50 500	340	420	2 230	355	1 870	0.65	
60	7x11x9	M6x1x12	20	3 960 [3 500]	33 500	26 800	46 000	360	320	1 840	267	1 540	0.63	3.6
					45 500	36 500	71 000	555	725	3 700	610	3 100	0.93	
80	9x14x12	M8x1.25x15	20	4 000 [3 500]	47 000	37 500	63 000	600	505	3 150	425	2 650	1.2	5.2
					61 000	48 500	91 500	870	1 030	5 600	865	4 700	1.6	
80	9x14x12	M8x1.25x17	20	4 000	62 500	49 500	80 500	950	755	4 500	630	3 800	1.7	7.2
					81 000	64 500	117 000	1 380	1 530	8 350	1 280	7 000	2.4	
105	14x20x17	M12x1.75x24	22.5	3 990	107 000	84 500	140 000	2 140	1 740	9 750	1 460	8 150	3.0	12.3
					131 000	104 000	187 000	2 860	3 000	15 600	2 520	13 100	3.9	
120	16x23x20	M14x2x24	30	3 960	158 000	125 000	198 000	3 600	3 000	16 300	2 510	13 700	5.0	16.9
					193 000	153 000	264 000	4 850	5 150	26 300	4 350	22 100	6.5	

- 5) The basic load rating comply with the ISO standard. (ISO 14728-1, 14728-2)
- C₅₀: the basic dynamic load rating for 50 km rated fatigue life C₁₀₀: the basic dynamic load rating for 100 km rated fatigue life
- The basic static load rating shows static permissible load.