

Soft Absorber

Fixed Type Adjustable type Self-adjusting

FK-6450/64100/64150/※64200 Series

RoHS Compliant

●Products specification might be changed without notice.



Specifications

Model	Stroke mm	Max. absorption energy J (kgf·m)	Max. equivalent mass kg (kgf)	Range of impact rate m/s	Max. drag N (kgf)	Max. cycle rate cycle/min	Max. absorption energy per minute J/min (kgf·m/min)	recovering power of the piston rod N (kgf)	Operating temperature °C	Mass kg	Allowable eccentric angle °				
FK-6450L-C	50	2,000 (204.7)	2,800~36,000(2,800~36,000)	0.1~0.5	90,000 (9,184)	10	164,608 (16,797)	150 (15.3)	-5~70	2.5	±2.5				
FK-6450M-C			390~4,000(390~4,000)	0.3~1.5		15									
FK-6450H-C			130~500(130~500)	0.3~3.6		15									
FK-64100L-C	100	4,000 (408.2)	4,000~40,000(4,000~40,000)	0.1~0.6		90,000 (9,184)	8	214,118 (21,849)		180 (18.4)	-5~70	3.2	±1.0		
FK-64100M-C			1,000~7,000(1,000~7,000)	0.3~1.5			10								
FK-64100H-C			250~1,300(250~1,300)	0.3~3.6			10								
FK-64150L-C	150	6,000 (612.2)	9,000~56,000(9,000~56,000)	0.1~0.6			90,000 (9,184)	6		275,556 (28,118)		370 (37.8)	-5~70	4.2	±1.0
FK-64150M-C			1,200~11,000(1,200~11,000)	0.3~1.5				8							
FK-64150H-C			350~2,200(350~2,200)	0.3~3.6				8							
FK-64200-C-□□□ Note 1	200	8,000(816.3)	—	—	90,000 (9,184)			—	—	400(40.8)		-5~70		5.5	±1.0

Note 1) □ for FK-64200-C-□□□ will be filled in with a branch number. (made to order product)

Precautions for Use

- * Do not use this product without carefully reading the attached owner's manual.
- * Do not turn the oil inlet screw located at the bottom of the main unit.
- * We recommend that you use it with an external stopper (Stopper nut OP-020M64□).
- * Ensure that sufficient mounting strength is secured for this product. (As a guideline, it should be 2 to 3 times the maximum drag listed in the catalog.)
- * Do not use this product in a vacuum or a location where it may come in contact with oil.
- * Ensure that an eccentric load is not applied to the soft absorber.
- * The urethane caps are consumables. Please replace them when necessary.
- * FK-64200-C-□□□ is only for emergency stop; it is not designed for normal use. (Customized orders)

Soft Absorber

Fixed Type Adjustable type Self-adjusting

FK Series (M64)

RoHS Compliant

● Products specification might be changed without notice.

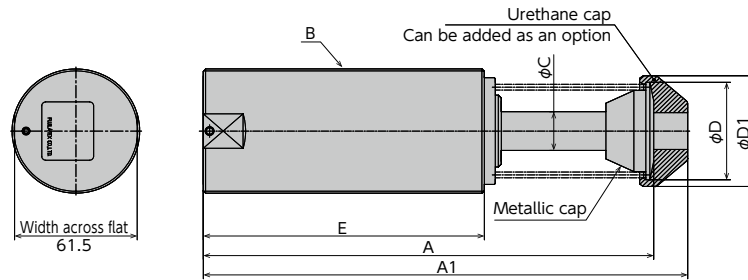

* The absorber's main unit does not come with nuts.

Dimensions

Model	A	A1	B	ϕC	ϕD	$\phi D1$	E
FK-6450□-C	226	243	M64×2	20	50.2	57	141
FK-64100□-C	328	345					191
FK-64150□-C	456	473			241		
※FK-64200-C-□□□	556	573			291		

* A1 and D1 are dimensions with the optional urethane cap attached. (Urethane cap type: OP-090M64A)

* The optional parts are common with those of the adjustable type. Please refer to page 81.

* FK-64200-C-□□□ are made to order.

Key to Model Number

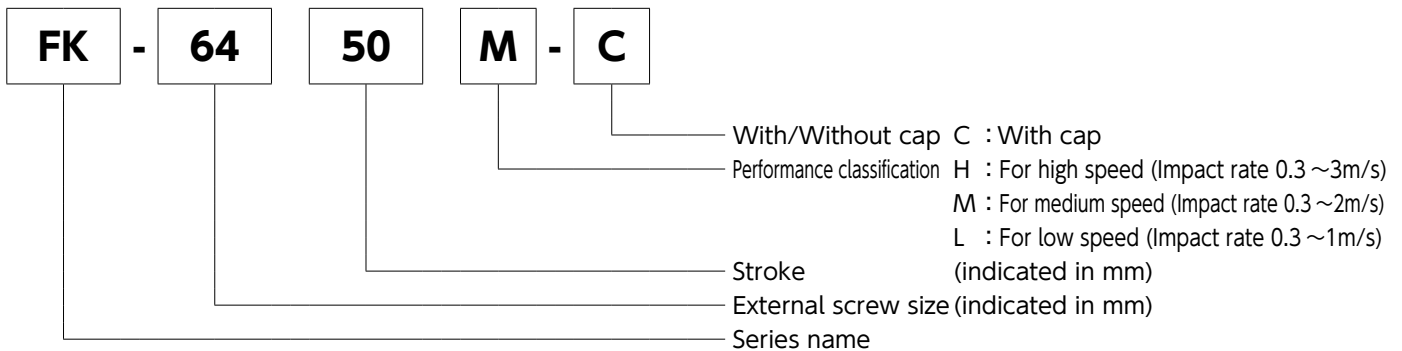

Soft Absorber

FK Series

RoHS Compliant

● Products specification might be changed without notice.

Optional Parts Compatibility Chart

Model	Eccentric angle adaptor	Stopper nut		Holder with a switch	Flange	Liquid-proof cap	Urethane cap	Nut
		Without cap	With cap					
FK-1008□-*	OP-010PB	OP-020PB-S	OP-020PB-C	—	OP-040PB	FK-1008□-C-060	OP-090M10A	—
FK-1210□-*	OP-010KB	OP-020KB-S	OP-020KB-C	OP-032KB	OP-040KB	FK-1210□-C-060	OP-090M12A	—
FK-1412□-*	OP-010RD	OP-020RB-S	OP-020RB-C	OP-032RB	OP-040RB	FK-1412□-C-060	OP-090M14A	—
FK-1417□-*	—	OP-020RB-S	OP-020RB-C	—	OP-040RB	—	OP-090M14B	—
FK-1612□-*	OP-010XB	OP-020HB-S	OP-020HB-C	OP-032HB	OP-040XB	FK-1612□-C-060	OP-090M16A	—
FK-2016□-*	OP-010EB	OP-020EB-S	OP-020EB-C	OP-032EB	OP-040EB	FK-2016□-C-060	OP-090M20A	—
FK-2022□-*	—	OP-020EB-S	OP-020EB-C	—	OP-040EB	—	OP-090M20A	—
FK-2050□-R	—	OP-020EB-S	OP-020EB-C	—	OP-040EB	—	OP-090M20A	—
FK-2530□-*	OP-010GB	OP-020GB-S	OP-020GB-C	OP-032GB	OP-040GB	FK-2530□-C-060	OP-090M25A	—
FK-2540□-*	—	OP-020LB	OP-020LB	—	OP-040GB	—	OP-090M25A	—
FK-2550□-R	—	—	—	—	—	—	OP-090M25A	—
FK-2725□-*	OP-010FB	OP-020FB-S	OP-020FB-C	OP-032FB	OP-040FB	FK-2725□-C-060	—	—
FK-3035□-*	OP-010TB	OP-020TB-S	OP-020TB-C	—	OP-040TB	FK-3035□-C-060	OP-090M30A	—
FK-3625A□-C	OP-010M3625	—	OP-020M36	—	OP-040UB	—	OP-090M36B	—
FK-3650A□-C	OP-010M3650	—	OP-020M36	—	OP-040UB	—	OP-090M36B	—
FK-3650□-*	OP-010UB	OP-020UB-S	OP-020UB-C	—	OP-040UB	—	OP-090M36A	—
FK-4225B□-C	OP-010M4225	—	OP-020M42	—	Square flange OP-040M42SF	—	OP-090M42A	OP-M42
FK-4250B□-C	OP-010M4250	—	OP-020M42	—	Rectangle flange OP-040M42RF	—	OP-090M42A	OP-M42
FK-4275B□-C	—	—	OP-020M42	—	—	—	OP-090M42A	OP-M42
FK-6450□-C	—	—	OP-020M64S	—	—	—	OP-090M64A	OP-M64
FK-64100□-C	—	—	OP-020M64S	—	Square flange OP-040M64SF	—	OP-090M64A	OP-M64
FK-64150□-C	—	—	OP-020M64L	—	—	—	OP-090M64A	OP-M64

*Standard nuts are sold separately as well.

Applicable Models	Model
FK-0404	M04 nut
FK-0604	M06 nut
FK-1008	M10 nut
FK-1210	M12 nut
FK-1412	M14 nut
FK-1417	M14 nut
FK-1612	M16 nut
FK-2016	M20 nut
FK-2022	M20 nut
FK-2050	M20 nut
FK-2530	M25 nut
FK-2540	M25 nut
FK-2550 P2.0	M25-P2 nut
FK-2725	M27 nut
FK-3035	M30 nut
FK-3625A	M36A nut
FK-3650A	M36A nut
FK-3650	M36 nut

Soft Absorber

FK Series

RoHS Compliant

● Products specification might be changed without notice.

Optional Parts

Eccentric angle adaptor OP-010

Model	A	B	C	D	E	F	G	H	I	J	K	Mass g
OP-010PB	38	28	2	8	6	8	M16×1.5	19	21.9	13	65	35
OP-010KB	48	35	3	10	5	10	M18×1.5	21	24.3	14	85	48
OP-010RD	53	38	3	12	7	11	M22×1.5	24	27.7	19	95	84
OP-010XB	60	45	3	12	7	12	M22×1.5	24	27.7	19	102	81
OP-010EB	68	49	3	16	10	14	M27×1.5	32	37	24	129	209
OP-010GB	107.5	67.5	10	30	15	16	M36×1.5	46	53.1	32	197.5	639
OP-010FB	97	62	10	25	15	16	M36×1.5	46	53.1	32	170	587
OP-010TB	127	82	10	35	15	18	M40×1.5	50	57.7	36	239	852
OP-010UB	167	107	10	50	15	20	M45×1.5	55	63.5	41	306	1,273
OP-010M3625	131	97	10	24	15	22	M45×1.5	55	63.5	41	200	880
OP-010M3650	201	142	10	49	15	22	M45×1.5	55	63.5	41	312	1,270
OP-010M4225	133	99	10	24	—	28	M64×2	—	—	—	194	1,600
OP-010M4250	203	144	10	49	—	28	M64×2	—	—	—	290	2,500

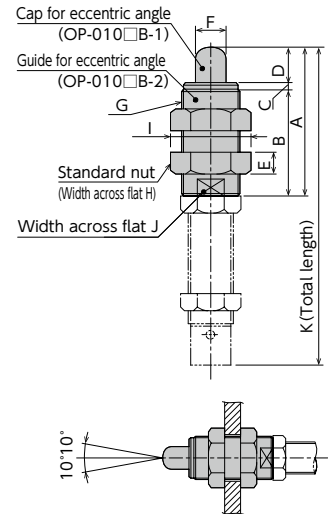

When attaching the eccentric angle adaptor, screw it into the main unit until the cap for eccentric angle and the piston rod form a tight connection. While maintaining this position, fasten the main unit's nut until secured.

* If the eccentric angle adaptor is secured without establishing a tight fit, a sufficient stroke cannot be obtained. Furthermore, if the eccentric angle adaptor is further screwed in, after it has formed a tight connection, and then secured in place, the cap for eccentric angle cannot be pushed all the way to the stroke end.

● The inclined adapter is not available for models with soft absorber cap (-C) and urethane cap (-R)

Stopper nut OP-020

Model	Standard OP-020□-S		With cap OP-020□-C		Common dimensions		Mass g	
	A	B	C	D	E	F	S	C
OP-020PB-S-C	10	15	16	15	13	M10×1	6	9
OP-020KB-S-C	12	16.2	16	16.2	14	M12×1	6	8
OP-020RB-S-C	12	19.6	20	19.6	17	M14×1.5	10	17
OP-020HB-S-C	15	21.9	30	21.9	19	M16×1.5	15	28
OP-020EB-S-C	30	27.7	47	27.7	24	M20×1.5	46	68
OP-020GB-S-C	20	37	32	37	32	M25×1.5	65	102
OP-020LB	—	—	50	37	32	M25×1.5	153	
OP-020FB-S-C	35	37	55	37	32	M27×1.5	90	137
OP-020TB-S-C	38	41.6	58	41.6	36	M30×1.5	129	197
OP-020UB-S-C	45	53.1	65	53.1	46	M36×1.5	291	422
OP-020M36	—	—	45	53.1	46	M36×1.5	291	
OP-020M42	—	—	59	φ56	—	M42×1.5	370	
OP-020M64S	—	—	86	φ78	—	M64×2	850	
OP-020M64L	—	—	115	φ78	—	M64×2	1,150	

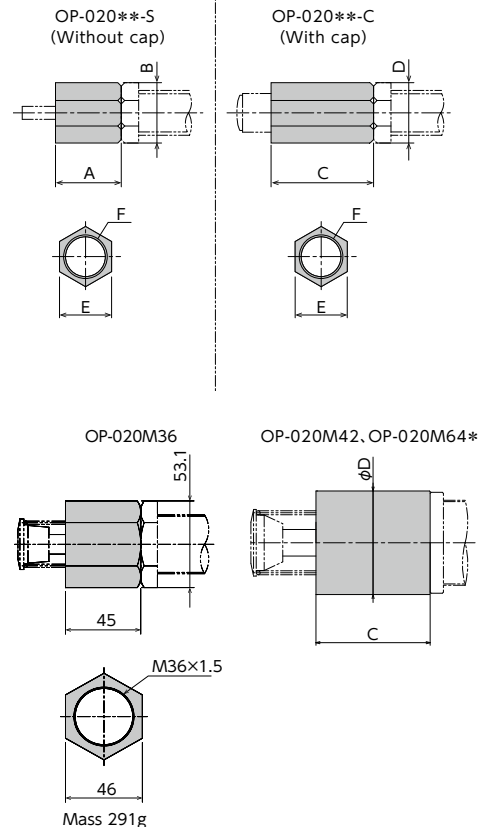

● Adjust so that it stops 1mm before the stroke end, and fasten with the main unit's nut until secured.

Note) When attaching, make sure that the side without a bearing chamfer is the impact surface.

Soft Absorber

FK Series

RoHS Compliant

●Products specification might be changed without notice.

Optional Parts

Holder with a switch OP-032

Model	A	B	φC	D	E	F	(G)	H	J	Mass g
OP-032KB	29	23	8	10	8	8	19.6	12.8	16	38
OP-032RB	29	23	10	12	8	8	19.6	13.8	17	34
OP-032HB	40	23	13.5	12	15	8	21.9	14.8	19	46
OP-032EB	50	23	18	16	17	8	27.7	17.3	24	80
OP-032GB	37	23	22	30	18	8	33.5	19.8	29	82
OP-032FB	56	23	23	25	20	8	34.6	20.3	30	107

- Position the holder in such a way that the tip of the switch and one of the ends of the metal ring for the rod cap are separated more than 0.5 mm. Cause of malfunction.
- Please refer to below for the specification of switches and precautions for use.

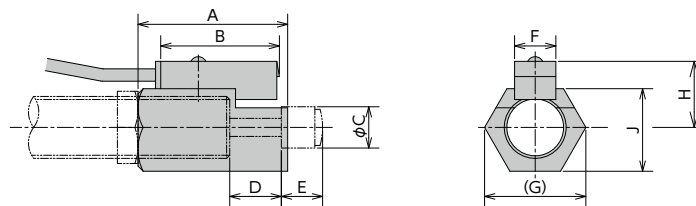

Model GXL-8F specifications Manufactured by SUNX

Item	Summary	Specification
Detection distance	Standard detected object 15X15X1 (Iron)	2.1mm
Power voltage		12~24VDC±10%
Consumption current		15mA or lower
	Behaviour form	NO type
	Output form	NPN open collector
	Output capacity (with 24VDC power voltage)	100mA or lower
	Protection feature	Comes with a surge absorption circuit
	Residual voltage At 100mA inflowing current	2V or lower
	<p>λ Input/Output circuit diagram</p> <p>Operation indicator light Red LED (lights up when the output is ON)</p>	
Response frequency		500Hz
Ambient operating temperature		-25~70°C
Ambient storage temperature		-40~85°C
Ambient operating humidity		35~85%RH
Ambient storage humidity		35~95%RH
Lead wire length		Approximately 1m
Mass	Including cable	Approximately 15g

1) Do not use when it is in a transient state after the power is turned on (approx.10ms).

2) Keep the cables as short as possible when using in places with a lot of noise.

Also, please take all precautions, such as avoiding the parallel wiring of electric lines and power lines, as well as wiring within the same conduit.

3) Ensure that the switch does not come in direct contact with thinner-type chemicals.

4) Because it does not have a short-circuit protection circuit, wiring must be done correctly.

Soft Absorber

FK Series

RoHS Compliant

● Products specification might be changed without notice.

Optional Parts

Flange OP-040

Model	A	B	C	D	E	Mass g
OP-040PB	25	18	M10×1	3.2	4	16
OP-040KB	25	18	M12×1	3.2	4	15
OP-040RB	34	24	M14×1.5	4.5	4	30
OP-040XB	34	24	M16×1.5	4.5	4	29
OP-040EB	40	28	M20×1.5	6.5	12	109
OP-040GB	54	40	M25×1.5	9	12	206
OP-040FB	50	36	M27×1.5	9	12	157
OP-040TB	65	45	M30×1.5	11	14	344
OP-040UB	78	56	M36×1.5	14	16	566

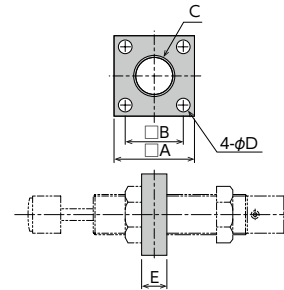

● This is a mounting fixture for soft absorbers.

Liquid-proof cap -060

Model	A	B	C	D	E	Mass g
FK-1008□-C-060	13	18	3	8	55	10
FK-1210□-C-060	17	28	9.5	10	71.5	25
FK-1412□-C-060	19	30	9	12	78.5	31
FK-1612□-C-060	21	34	9.5	12	87.5	46
FK-2016□-C-060	24	35	4	16	108	59
FK-2530□-C-060	28	51	6.5	30	154.5	77
FK-2725□-C-060	30	50	5	25	137.5	112
FK-3035□-C-060	38	60	5	35	191.5	255

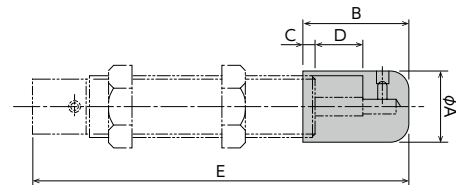

- The main unit is supplied in assembly
 - □ will be filled in with either of L, M, or H indicated in the catalog.
 - Ideal for use in environments where oil splatter poses a problem.
 - Ensure that the cap is facing upward. If the cap is facing sideways or downward, it cannot provide an effective means for liquid proofing.
- Note) Liquid-proof caps are not sold separately.

Urethane cap OP-090

Model	A	C	Mass g
OP-090M36B	10	34	7
OP-090M42A	24.5	44	22
OP-090M64A	(24.1)	57	35

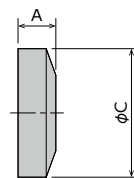

OP-090M36B

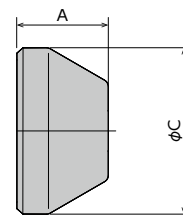

OP-090M42A
OP-090M64A

Nut

Model	A	B	C	D	E	Mass g
OP-M42	53	M42×1.5	4-φ4.6	4-2.5	10	64
OP-M64	76	M64×2.0	4-7	2-70	10	100

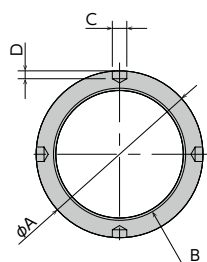

OP-M42

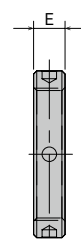

Mass 64g

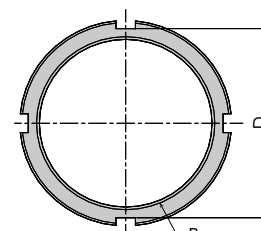

OP-M64

Mass 100g

